

**INVITATION FOR BIDS  
CONTRACT No. 2024-03**

**for**

**Johnson Pier Electric  
Upgrades**

San Mateo County Harbor District



## **NOTICE INVITING BIDS**

**NOTICE IS HEREBY GIVEN** that sealed bids will be received in the Harbor District Administrative Offices, San Mateo County Harbor District (District), either by U.S. Postal Service addressed to its mailing address, PO Box 1449, El Granada, CA 94018, or by courier or personal delivery to 504 Avenue Alhambra, 2<sup>nd</sup> Floor, El Granada, CA 94018, on **June 5, 2024 by 2:00 p.m., Pacific Standard Time**, at which time bids will be publicly opened and read for the following:

### **CONTRACT NO. 2024-03** **Johnson Pier Electric Upgrades**

The District seeks bids for the **Johnson Pier Electric Upgrades**. Bids shall be submitted on the District's "Bid Form" and enclosed in a sealed envelope marked "**CONTRACT NO. 2024-03, Johnson Pier Electric Upgrades,**" and plainly endorsed with Bidder's name and address.

Bids will be accepted only from pre-qualified bidders. Your attention is directed to the Request for Pre-Qualification of Bidders issued concurrently herewith. It is mandatory that all Contractors who intend to submit a bid, fully complete the pre-qualification questionnaire, provide all materials requested in the Request for Pre-Qualification of Bidders, and be approved by San Mateo County Harbor District to be on the final qualified bidders list. No bid will be accepted from a Contractor that has failed to comply with these requirements.

Bidders bidding as the prime contractor must possess a valid State of California **Class A**, Contractor's License at the time of contract award. All subcontractors, if any, must be properly licensed by the State of California to perform specialized trades.

A mandatory pre-bid conference and site visit will be held prior to the date of bid opening. District staff will be available to answer general questions pertaining to the solicitation documents and the specifications. Any questions that may require staff research to answer or that will otherwise modify the meaning or intent of this solicitation shall be submitted to the District in writing as described in Special Provision 1.8. The pre-bid conference will take place on **May 3, 2024 at 2:00 pm at the Pillar Point Harbor – Harbor Master's Office**. There will be a site visit immediately following the pre-bid conference. The project site is not an active construction site and personal protective equipment (PPE) is not required for the pre-bid conference site visit.

Bids must be accompanied by a deposit either in the form of a certified or cashier's check or Bidder's Bond, as described in the documents, which shall be applied to damages sustained by the District in the event that the successful Bidder fails or refuses to enter into a contract awarded to it by the District.

Requests for modifications or clarifications of any requirement must be submitted in writing to San Mateo County Harbor District, attn: Capital Improvement Projects (Johnson Pier Electric Upgrades) by e-mail at [jmoren@smharbor.com](mailto:jmoren@smharbor.com) by **May 15, 2024 at 4:30 p.m., Pacific Standard Time**.

This is a Public Works Contract. The general prevailing rates of per diem wages and the general prevailing rates for regular (straight) time, holiday and overtime work in San Mateo County for each craft, classification and type of worker needed to execute the Contract shall be set forth in the current General Prevailing Wage Determinations made by the Director of Industrial Relations pursuant to California Labor Code Sections 1720 et seq. The current General Prevailing Wage Determinations are

incorporated into the Contract and are available at the California Department of Industrial Relations' website ([www.dir.ca.gov/dlsr/DPreWageDetermination.htm](http://www.dir.ca.gov/dlsr/DPreWageDetermination.htm)). Should the general prevailing wage rates not specify a wage determination for a particular type of worker, attention is directed to 8 CCR 16202(b) regarding petitioning the Director of the California Department of Industrial Relations for a special wage determination. Responsibility for labor law enforcement remains with the Division of Labor Standards Enforcement.

The successful Bidder will be required to furnish a Performance Bond and a Payment Bond, both in the amount set forth in the Special Provisions.

Pursuant to Public Contract Code Section 22300, the successful Bidder may submit certain securities in lieu of the District withholding funds from progress payments (retention) during the Project.

Bids will be examined and reported to the General Manager within ninety (90) calendar days after the bids have been opened. The District reserves the right to reject any and all bids, or to waive any irregularities or informalities in any bid or in the bid procedure, or to postpone the bid opening for good cause. No Bidder may withdraw its bid for a period of ninety (90) calendar days after the date of opening of the bids. Each Bidder will be notified of award of contract, if award is made.

Contractors and subcontractors must be registered with the Department of Industrial Relations (DIR) at the time of bid, or else the bid may be rejected as non-responsive. (See Labor Code sections 1725.5 and 1771.1.) For federally funded projects, the contractor and subcontractors must be registered at the time of contract award. (See Labor Code section 1771.1(a)). Each bidder must submit proof of contractor registration with DIR (e.g. a hard copy of the relevant page of the DIR's database found at: <https://efiling.dir.ca.gov/PWCR/Search>). This Contract is subject to monitoring and enforcement by the DIR pursuant to Labor Code Section 1771.4.

To inspect and obtain the Bid Documents or for additional information, please contact San Mateo County Harbor District, Capital Improvement Projects by e-mail a mail to: [jmoren@smharbor.com](mailto:jmoren@smharbor.com). or on District website; [smharbor.com](http://smharbor.com).

Dated at El Granada, this Date. April 19, 2024

**CONTRACT NO. 2024-03**  
**Johnson Pier Electric Upgrades**

**GENERAL CONDITIONS AND INSTRUCTIONS FOR BIDDERS**

## SAN MATEO COUNTY HARBOR DISTRICT

### GENERAL CONDITIONS AND INSTRUCTIONS FOR BIDDERS

These General Conditions and Instructions apply to all bids, except insofar as they may be modified by the Special Provisions, Technical Specifications or Bid Forms.

1. **Definition of Terms.** Whenever in the Bid or Contract Documents the following terms or pronouns in place of them, or abbreviations are used the intent and meaning shall be interpreted as follows:

"District" shall mean San Mateo County Harbor District.

"Board," "Director," "Directors," or "Board of Directors" shall mean the five (5) member governing board of the San Mateo County Harbor District or members thereof.

"Secretary" means the Administrative Assistant/Deputy Secretary of the Board of the San Mateo County Harbor District.

"General Manager" means General Manager of the San Mateo County Harbor District.

"Contractor" means the successful bidder to whom a contract is awarded.

"Written Order" means a written order signed by the General Manager or properly authorized representative or agent, mailed to the Contractor at the address designated in the firm's Bid, or to such other address as may be designated in writing as its official place of business.

"Bid Documents" or "Contract Documents" mean the Notice Inviting Sealed Bids, General Conditions and Instructions for Bidders, Special Provisions, Technical Specifications, Bid Forms and Addenda, if any.

"Bidder" or "Bid" means Proposer or Proposal, respectively.

2. **Explanations and Clarifications**

- A. **Request for Interpretation or Correction.** Prospective Bidders must examine the Contract Documents carefully. It shall be the duty of every person contemplating submitting a Bid for the proposed Contract, to contact the Secretary and request in writing, before bidding, an interpretation or correction of every discrepancy, ambiguity, error or omission in any of the Contract Documents which should have been discovered by a reasonably prudent Bidder.

Any interpretation, change or correction of said Contract Documents will be made by addenda only, duly issued by the District. Copies of such addenda will be mailed or delivered to each firm receiving a set of said specifications. Upon such mailing or delivery, such addendum will become a part of the Contract Documents, and binding on all Bidders whether or not actual notices of such addenda are shown.

- B. **Interpretations or Corrections Binding.** Only the written interpretation or correction so given by the District shall be binding. All oral modifications of the Contract Documents are void and ineffective.
3. **Form of Bid and Signature.** The Bid shall be made on the form provided and shall be enclosed in a sealed envelope marked and addressed as required. If the Bid is made by a sole owner, it shall be signed with the firm's full name and its address shall be given; if it is made by a partnership, it shall be signed with the partnership name by a member of the firm, who shall also sign its own name, and the name and address of each member of the firm shall be given; and if it is made by a corporation it shall be signed by **two** officers of the corporation, consisting of (1) the chairman of the board, president, or vice president, and (2) the secretary, assistant secretary, chief financial officer, assistant financial officer, or by a person authorized by the corporation to execute written Contracts on its behalf. If the Bid made by a corporation is signed by a person other than an officer, or by only one officer, there must be attached to the Bid a certified copy of a resolution of the corporation authorizing such officer or person to sign Bids on behalf of the corporation. If it is made by a joint venture, it shall be signed on behalf of each participating company by officers or other individuals who have the full and proper authorization so to do. If it is made by an LLC, it must be signed by an officer or other member who has full and proper authorization to execute contracts on behalf of the LLC. Bids submitted in any other form will be considered non-responsive and may be rejected.
4. **Bid Form.** Blank spaces in the Bid shall be properly filled. The phraseology of the Bid must not be changed and no additions shall be made to the items mentioned therein. Alterations by erasure or interlineations must be explained or noted in the Bid over the signature of the Bidder. If the unit price and the total amount named by a Bidder for any item do not agree, the unit price alone will be considered as representing the Bidder's intention. Any mathematical errors apparent on the face of the Bid shall be corrected and the mathematically correct total shall be used to determine the lowest Bidder.
5. **Unauthorized Conditions.** Unauthorized conditions, limitations or provisions attached to a Bid will render it informal and may cause its rejection. No telegraphic Bids or modifications will be considered.
6. **Submission of Bid.** Prior to the hour specified in the notice inviting sealed Bids, all Bids shall be delivered to the Secretary at the address shown in the Notice. All Bids shall be in a sealed envelope properly endorsed as to the item being Bid and the Bidder's name and address. No Bids received after said time or at any place other than the time and place as stated in the notice will be considered.
7. **Withdrawal of Bid.** Any Bid may be withdrawn at any time prior to the time fixed in the public notice for the opening of Bids only by written request for the withdrawal of the Bid filed with the District. The request shall be executed by the Bidder or its duly authorized representative.

A telephonic request is not acceptable. The District will accept facsimile or email transmissions of properly executed requests that are received by the District prior to the time fixed in the public notice for the opening of Bids. The District will not be responsible for interruptions, delays, or any other unsuccessful facsimile or email transmission of Bid

withdrawals, whether or not caused by the District's facsimile equipment. The withdrawal of a Bid does not prejudice the right of the Bidder to file a new Bid. Whether or not Bids are opened exactly at the time fixed in the public notice opening Bids, a Bid will not be received after that time, nor may any Bid be withdrawn after the time fixed in the public notice for the opening of Bids.

8. **Canvass of Bid.** At the hour specified in the notice, the Secretary will open, examine and publicly declare all Bids received. Bidders, their representatives, and others interested are invited to be present at the opening of Bids. Award will be made or Bids rejected by the District within the time specified in the Specifications or Bid Forms or, if not specified, within a reasonable time after Bids have been opened. The District reserves the right to postpone the Bid opening for its own convenience.
9. **Award of Contract.** The award of the Contract, if awarded, will be made to the lowest responsible Bidder whose Bid complies with the requirements prescribed and whose qualifications are satisfactory to the District. Such award, if made, will be made within ninety (90) days after the opening of the Bids. If the lowest responsible Bidder refuses or fails to execute the Contract or file the required bonds, the District may award the Contract to the second lowest responsible Bidder. The periods of time specified above within which the award of Contract may be made shall be subject to extension for such further period as may be agreed upon in writing between the District and the Bidders concerned. All Bidders shall be notified of the award.
10. **Rejection of Bids.** The District may reject any and all Bids. The District also reserves the right to waive any irregularities or informalities in any Bid or in the bidding procedure. All Bidders shall be notified of the award. All Bids must remain in effect at least ninety (90) days from the Bid opening date.
11. **Taxes.** The supplies, materials or equipment called for under the Specifications will be used by the District in the performance of a governmental function and are exempt from taxation by the United States Government, and the District will, if requested, furnish a tax exemption certificate and any and all affidavits and documents that may be necessary to establish such exemption. California State sales or use taxes shall be included in the Bid price.
12. **Additional Taxes.** Any sales tax, use tax, imposts, revenues, excise, or other taxes which may hereafter be imposed by the State of California or any political subdivision thereof, and applicable to the sale of the material delivered as a result of the Bidder's Bid and which, by the terms of the tax law may be passed directly to the purchases, will be included in the Bid price.
13. **Alternative Bid.** Submission of alternative Bid or Bids, except as specifically called for in the Specifications or Bid Forms, will render it informal and may cause its rejection.
14. **Bidder's Security.** Each Bidder shall submit with its Bid one of the following forms of Bidder's security:
  - (a) An unconditional Certified or Cashier's Check on a solvent bank, in an amount equal to at least ten percent (10%) of the amount Bid, payable to the order of San Mateo County Harbor District; or

- (b) A Bidder's Bond, in an amount equal to at least ten percent (10%) of the amount Bid, using the form entitled "Bidder's Bond," provided with the Bid documents, and properly executed and acknowledged by the Bidder and by a corporate surety authorized to transact such business in the State of California and acceptable to the District.

Any condition or limitation placed upon said check or any alteration of said form of bond, or imperfection in the execution thereof, as herein required will render it informal and may, at the option of the District, result in the rejection of the Bid under which such check or bond is submitted. Said check or Bidder's Bond shall be a guarantee that the Bidder(s), if awarded the Contract, will execute the required Contract and bonds within fifteen (15) days after receipt of the contract and bond forms from the District or such additional time as may be allowed by the District. If the Bidder(s) fails or refuses to execute the required Contract and bonds within said time, the money and proceeds from the check or bond as the case may be, shall be applied towards payment of the damage to the District on account of the delay in the execution of the Contract and bonds and the performance of the work thereunder, and the necessity of accepting a higher or less desirable Bid resulting from such failure or refusal to execute the Contract and bonds required. The amount of the check or bond as the case may be, shall not constitute a limitation upon the right of the District to recover for the full amount of such damage. The check or bond of the successful Bidder(s) and the next two highest Bidders will be returned after the execution of the Contract with the successful Bidder(s) and the approval of its bonds on behalf of the District, and the checks or bonds of the other Bidders will be returned promptly after the Bids have been opened and reviewed by the District.

15. **Permits and Licenses.** To the extent permit and licensing requirements are applicable, the Contractor shall procure all permits and licenses, pay all charges and fees, and give all notices necessary and incident to the due and lawful prosecution of the work.
16. **Statement of Experience and Qualifications.** Upon request, the Bidder may be required to prove to the District's satisfaction that it has the skill and experience and that it has the necessary facilities and ample financial resources to perform the Contract in a satisfactory manner and within the required time.
17. **Waiver.** The Bidder shall represent and warrant that it has sufficiently informed itself in all matters affecting the performance of the work or the furnishing of the labor, supplies, material or equipment called for in the Specifications; that Bidder has checked its Bid for errors and omissions; that the prices stated in its Bid are correct and as intended by it and are a complete and correct statement of its prices for performing the work or furnishing the labor, supplies, materials or equipment required by the Contract Documents.

The Bidder waives any claim for the return of its Bid deposit if, on account of errors or omissions claimed to have been made by it in its Bid, or for any other reason, it should refuse or fail to execute the Contract.

18. **Non-Collusion Certification.** By submitting a Bid, the Bidder represents and warrants that such Bid is genuine and not sham or collusive or made in the interest or in behalf of any person not therein named, and that the Bidder has not, directly or indirectly, induced or solicited any other Bidder to put in a sham Bid, or any other person, firm or corporation to



refrain from bidding, and that the Bidder has not in any manner sought by collusion to secure to the Bidder an advantage over any other Bidder.

19. **Penalty for Collusion.** If at any time it shall be found that the person, firm or corporation to whom a Contract has been awarded has, in presenting any Bid or Bids, colluded with any other party or parties, then the Contract so awarded shall be null and void and the Contractor and its bondsmen shall be liable to the District for all loss or damage which the District may suffer thereby and the District may advertise for a new Contract for said labor, supplies, materials or equipment.
20. **Interest of District Personnel.** By submitting a Bid, the Bidder represents and warrants that neither the General Manager, nor any Director, officer or employee of the District is in any manner interested directly or indirectly in the Bid or in the Contract which may be made under it, or in any expected profits to arise therefrom, as set forth in Article 4, Division 4, Title 1 (commencing with Sec. 1090) or Title 9 (commencing with Section 8100 of the Government Code of the State of California).
21. **Representation Before the District.** No person previously in the position of Director, Officer, employee, or agent of the District may act as an agent or attorney for, or otherwise represent, a Bidder or Contractor by making any formal or informal appearance, or any oral or written communication, before the District, or any officer or employee of the District, for a period of twelve months after leaving office or employment with the District, if the appearance or communication is made for the purpose of influencing any action involving the issuance, amendment, award, or revocation of a permit, license, grant or Contract.
22. **Time for Execution of Contract and Filing Bond.** The Bidder(s) to whom award is made shall execute a written Contract with the District on the form of Contract of the District and furnish good and approved bonds and provide evidence of insurance as herein required within fifteen (15) days after receiving the forms of Contract and bond for execution.

If the Bidder to whom award is made fails to enter into the Contract as herein provided and furnish the bonds and evidence of insurance, the award will be annulled and an award may, in the discretion of the District, be made to the Bidder whose Bid is next most acceptable; and such Bidder shall fulfill every stipulation embraced herein as if it were the party to whom the first award was made.

23. **Documents Deemed Part of Contract.** The Notice Inviting Sealed Bids, General Conditions and Instructions for Bidders, Special Provisions, Bid Form, Technical Specifications and Addenda, if any, and the Agreement will be deemed a part of the Contract.
24. **Governing Law: Compliance with Laws.** The Contractor hereunder shall be governed by the laws of the State of California. The Contractor must comply with all local, state and

federal laws, rules and regulations applicable to this Contract and to the work to be done hereunder, including, all rules and regulations of the District.

25. **Manner of Execution of Contract.** If the Contractor is an individual, the Contract shall be executed by the Contractor personally. If the Contractor is a co-partnership, it is desirable that the Contract be executed by all of the partners, but it may be executed by one of them. If the Contractor is a corporation, it must be executed by two officers of the corporation consisting of (1) the Chairman of the Board, President or Vice President; and (2) the Secretary, Assistant Secretary, Chief Financial Officer or Assistant Treasurer, or by a person authorized by the corporation to execute written Contracts on its behalf, and the corporate seal affixed thereto. If the corporate seal is not affixed to the Contract, or if it is executed by a person other than an officer, or by only one officer there must be attached to the Contract a certified copy of a resolution of the corporation authorizing such officer or person to execute written Contracts for and on behalf of the corporation. If the Contractor is a joint venture, the Contract must be executed on behalf of each participating firm by officers or other individuals who have the full and proper authorization so to do. If the Contractor is an LLC, the Contract must be executed by an officer or other member who has full and proper authorization to execute contracts on behalf of the LLC.
26. **Faithful Performance Bond.** Upon execution of the contract, the Contractor shall furnish a bond to guarantee the faithful performance of the contract. The amount of the bond shall be stated in the Special Provisions. The bond shall be with a California-admitted corporate surety, or with two or more sufficient sureties to be approved by the District. As an alternative to furnishing a bond, Contractor may guarantee faithful performance of the contract by (1) depositing with the District a certified check or cashier's check from a solvent bank for the prescribed amount.
27. **Payment Bond.** Upon execution of the contract, the Contractor shall furnish a bond to guarantee payment for costs of materials, equipment, supplies, and labor furnished in the course of the performance of the Contract. The amount of the bond shall be stated in the Special Provisions. The bond shall be with a California-admitted corporate surety, or with two or more sufficient sureties to be approved by the District.
28. **Effect of Extensions of Time.** Granting, or acceptance, of extensions of time to complete the work or furnish the labor, supplies, materials or equipment, or any one of the aforementioned, will not operate as a release to Contractor or the surety on Contractor's faithful performance bond from said guarantee.
29. **Changes by the Contractor.** If the Contractor, on account of conditions developing during the performance of the contract, finds it impracticable to comply with these Specifications and applies in writing for a modification of requirements, such change may be authorized only in writing by the General Manager, if not detrimental to the District.
30. **Changes by the District.** In case any work, materials or equipment shall be required which are not mentioned, specified or indicated or otherwise provided for herein, the Contractor shall, if ordered in writing by the General Manager, do and perform such work and furnish such materials or equipment at the Contractor's catalogue prices, less discounts ordinarily allowed to users of such materials or equipment or at regular labor charges less customary discounts, or both.

The Contractor's Bid to perform any changes requested by the District shall include the cost of the material, engineering time, labor for installation if required and a reasonable markup, if any.

In case any work, materials or equipment which are mentioned, specified or indicated or otherwise provided for in the contract or in the Specifications forming a part of the contract shall be required to be omitted from, in or about the work, the Contractor shall, if ordered by the General Manager, omit the performance of such work and the furnishing of such materials or equipment and there shall be deducted from the amount to be paid to the Contractor the amount which the General Manager and the Contractor shall determine and mutually agree to be the reasonable value of such work, materials or equipment, and such determination and agreement shall be final and conclusive upon the Contractor.

It is understood, however, that the amount of work, materials or equipment required by the Contract shall not, in accordance with the above provisions referring to additions or omissions, be so increased or diminished as substantially to alter the general character or extent of the Contract.

31. **Change Orders.** The Contract may be modified or changed by the District from time to time, in order to carry out and complete more fully and perfectly the work agreed to be done and performed. An order that modifies or changes work to be performed under the Contract shall be valid only if issued in writing and signed by the General Manager and shall designate (1) the change in cost or manner of payment, if any and (2) the effect on time for Contract performance, if any. Work so ordered must be performed by the Contractor.

32. **Disputed Work/Claims.** The Contractor must promptly comply with the following procedures in the event the Contractor has any dispute regarding (1) the District's determination on any change orders relative to adjustments in Contract price, time for performance or any other requirement or (2) whether a determination or order by the District violates the provisions of the Contract. Before proceeding with such work or complying with such determination or order, or simultaneously, the Contractor must notify the General Manager in writing of the reasons for the Contractor's opinion with respect to the dispute and request a final determination. The General Manager shall render the final determination within a reasonable time of receipt of such written request.

If the General Manager determines that the work in question is Contract work and not extra work, or that the determination or order complained of is proper, he/she will direct the Contractor to proceed, and the Contractor must promptly comply. However, in order to reserve its right to claim compensation for such work or damages resulting from such compliance, the Contractor must, within ten (10) days after receiving notice of the General Manager's determination and direction, notify the General Manager in writing that the work is being performed, or that the determination direction is being complied with under protest.

If the Contractor fails to so appeal to the General Manager for a determination, or having so appealed, should the Contractor thus fail to notify the General Manager in writing of its protest, the Contractor shall be deemed to have waived any claim for extra compensation or damage therefore. Oral appeals or oral protests, no matter to whom made, shall not be

deemed even substantial compliance with the provisions of this Section.

33. **Notice of Potential Claim.** The Contractor shall not be entitled to the payment of any additional compensation or damages for any cause, including any act or failure to act by the District, or the happening of any event, thing or occurrence, unless, it shall give the District due written notice of potential claim as described below. Compliance with this section shall not be a prerequisite as to matters within the scope of the protest provisions in General Condition 31, "Disputed Work/Claims."

The written notice of potential claim shall set forth the reasons for which the Contractor believes additional compensation or damages will or may be due, the nature of the cost involved and, insofar as possible, the amount of the potential claim. The notice must be given to the General Manager prior to the time that the Contractor shall have performed the work giving rise to the potential claim for additional compensation or damages, if based on an act or failure to act by the District, or in all other cases, within fifteen days after the happening of the event, thing or occurrence giving rise to the potential claim.

It is the intention of this section that differences between the parties arising under and by virtue of the Contract be brought to the attention of the District at the earliest possible time in order that such matters may be settled, if possible, or other appropriate action promptly taken. The Contractor agrees that it shall have no right to additional compensation or damages for any claim that may be based on any such act, failure to act, event, thing or occurrence for which no written notice of potential claim as required was filed.

34. **Contractor's Liability.** The Contractor will indemnify, keep and save harmless the District, its agents, officials and employees, against all suits or claims arising out of any injury or death to persons or property caused by, resulting from, relating to, or alleged to have been caused by, result from, or relate to, the acts or omissions of the Contractor (including its employees and subcontractors) , whether or not it has been alleged that the injury was caused through a negligent act or omission of the Contractor (or its employees or subcontractors), unless the injury was caused by the willful misconduct or the sole or active negligence on the part of the District, its agents, officials or employees. The Contractor will, at its own expense, defend any and all such actions, and will at its own expense pay all charges of attorneys and all costs and other expenses arising therefrom or incurred in connection therewith. If any judgment is rendered against the District in any such action, the Contractor will at its own expense satisfy and discharge the same.

35. **Approval by the General Manager.** The work shall be executed under the direction and supervision of the General Manager or his designee, on whose inspection all work shall be accepted or condemned. The General Manager shall have full power to reject or condemn any materials furnished or work performed under the Contract which do not conform to the terms and conditions set forth in the Contract Documents.

36. **Defective or Damaged Work.** The Contractor agrees that within ten calendar days after being notified in writing by the District of any work not in accordance with the requirements in the Contract or of any defects in the work, it will commence and prosecute with due diligence all work necessary to fulfill the requirements of the Contract or correct the defect and will complete such work in a reasonable period of time and at no additional cost to the District.

If the Contractor fails to promptly comply with this provision, the Contractor hereby authorizes the District to proceed to have such work done at the Contractor's expense, and Contractor agrees to honor and pay the costs and charges upon the District's demand. In the alternative, the District may elect to deduct the costs and charges from any compensation due or to become due to the Contractor. The District shall be entitled to all costs and expenses, including reasonable attorney's fees, necessarily incurred upon the Contractor's refusal to pay the above costs and charges. Nothing in the provision shall limit or restrict the warranty provisions set forth in the General Conditions, Special Provisions, and Technical Specifications.

37. **Independent Contractor.** Neither Contractor nor any of the Contractor's employees is, or shall be deemed, an agent or employee of the District, and in the performance of all work hereunder, Contractor shall be an independent Contractor, shall comply with all applicable Worker's Compensation laws, shall pay all required Social Security taxes and Unemployment Compensation taxes, and shall pay or perform all other obligations imposed upon an employer of labor, all at Contractor's expense, and, furthermore, shall indemnify the District against any and all liability as a result of Contractor's failure to perform any of the foregoing requirements.
38. **Protection of Work and of Persons and Property.** During performance and up to the date of final acceptance by the District, the Contractor shall be under an absolute obligation to protect the finished and unfinished work against any damage, loss or injury. In the event of damage, loss or injury to the finished and unfinished work, the Contractor shall promptly replace or repair such work, whichever the District shall determine to be preferable. The obligation to deliver finished work in strict accordance with the Contract shall be absolute and shall not be affected by the District's approval of or failure to prohibit means and methods of construction used by the Contractor.

During the performance of this Contract and up to the date of final acceptance, the Contractor must take all reasonable precautions to protect the persons and property of others from damage, loss or injury. Within three (3) days after notice to it of the happening of any such loss, damage or injury to work, persons and property, the Contractor shall make a full and complete report thereof in writing to the District.

Under this article the Contractor assumes the following distinct and several risks, whether they arise from acts or omissions (whether negligent or not) of the Contractor, or the District, or the District's Representative, or of third persons; or from any other cause, and whether such risks are within or beyond the control of the Contractor, excepting risks which arise solely from District or District Representative's active negligence or affirmative acts with actual and willful intent to cause the loss, damage and injuries, and professional errors and omissions of the District or of the District's Representative:

- a. The risk of loss or damage to the finished and unfinished Work prior to final acceptance by the District;
- b. The risk of claims, just or unjust, by third persons against the Contractor, the District or the District's Representative on account of injuries (including wrongful death), loss or damage of any kind whatsoever arising or alleged to arise out of or in connection with the performance of the Work (whether or not actually caused by or

resulting from the performance of the Work) or out of or in connection with the Contractor's operations or presence at or in the vicinity of the work site, whether such claims are made and whether such injuries, damage and loss are sustained at any time both before and after final acceptance of the Work;

- c. The risk of loss or damage to any property, including the loss of use thereof of the Contractor, and of claims made against the Contractor, the District, or the District's Representative for loss or damage to any property, including the loss of use thereof of subcontractors, material men, workmen and other performing the Work, occurring at any time prior to completion of removal of such property from the premises or in the vicinity thereof.

Neither the acceptance of the completed Work or payment therefore shall release the Contractor from its obligations under this article. The enumeration elsewhere in this Contract of particular risks assumed by the Contractor or of particular claims for which it is responsible shall not be deemed to limit the effect of the provisions of this article or to imply that it assumes or is responsible for only risks or claims of the type enumerated; and neither the enumeration in this article nor the enumeration elsewhere in this Contract of particular risks assumed by the Contractor or of particular claims for which it is responsible shall be deemed to limit the risks which the Contractor would assume or the claims for which it would be responsible in the absence of such enumerations.

Except as these specifications otherwise may provide, all loss or damage of any sort or nature arising from any unforeseen obstruction or difficulties, either natural or artificial, or from any act or omission not authorized by these specifications on the part of the Contractor, or any agent or person employed by it, shall be the responsibility of the Contractor.

The provisions of this Article shall not be deemed to create any new right of action in favor of third parties against the Contractor, or the District.

39. **Damages.** All loss or damage arising from any unforeseen obstruction or difficulties, whether natural or artificial, which may be encountered in the prosecution of the work, or the furnishing of the supplies, materials or equipment, or from any action of the elements prior to the final acceptance of the work or of the supplies, materials or equipment, or from any act or omission not authorized by these Specifications on the part of the Contractor or any agent or person employed by it shall be sustained by the Contractor.

40. **Failure to Complete Contract-Effect.** In case of failure on the part of the Contractor to complete its Contract within the specified time or within authorized extensions thereof, the Contract may be terminated and the District shall in such event not thereafter pay or allow to the Contractor any further compensation for any labor, supplies or materials furnished by it under said Contract; and the District may proceed to complete such Contract either by reletting or otherwise, and the Contractor and its bondsmen shall be liable to the District for all loss or damage which it may suffer on account of the Contractor's failure to complete its Contract within the specified time.

41. **Non-Performance of Contract.**

- a. **Right to Stop Work.** Authority to stop the work, in whole or in part is vested in the

District and may be invoked whenever it deems such action necessary to insure proper execution of the Contract; work may not be resumed until the District has given written consent.

- b. Rejection of Materials and Workmanship. The District has the right to reject defective material and workmanship and to require its replacement or correction without additional cost to District. Defective material and workmanship includes, but is not limited to, materials and workmanship that does not meet the requirements of the specifications of this Contract reasonably interpreted in the sole discretion of the District. Contractor shall promptly segregate and remove rejected work. All adjacent work disturbed by removal of such work shall be replaced in accordance with this Contract and without expense to the District including work of other contractors disturbed by such removals and replacements.
- (1) If Contractor fails to proceed at once with replacement of rejected work, District may, by Contract or otherwise, replace such material and correct such workmanship and charge the cost to the Contractor, or District may terminate right of the Contractor to proceed. The Contractor and its surety shall be liable for any damage to same extent as provided for by terminations hereunder.
  - (2) If rejected materials are not removed within a reasonable time, District may cause them to be removed and stored at Contractor's expense three days after issuing written notice to so remove them. If Contractor does not pay for such removal and storage within six days thereafter, District may, six days after further written notice, sell the materials and credit Contractor with net proceeds after all costs of removal and sale are deducted. If materials so removed are valueless or sale does not meet cost of removal, Contractor shall bear all resultant loss.
- c. Neglected Work. District may perform or employ others to undertake portions of the work persistently neglected by the Contractor if work is still proceeding unsatisfactorily three days after written notice to the Contractor. In such case work will be done according to the Contract Documents and the cost deducted from next payment falling due to the Contractor. Such action shall in no way affect status of either party under Contract, nor be held as basis of any claim by the Contractor or for extension of time.
- d. Right to Withhold Payment. Part or whole of any payment or any certificate may be withheld by District if such course is deemed necessary to protect District from loss on account of Contractor's failure to meet its obligations or if balances unpaid to Contractor are insufficient to complete the work. This right may also be exercised if in District's opinion the work will not be completed in time specified for performance of the Contract.
42. Termination of Right to Proceed. If the Contractor should appear to the District to be in default and the Contractor fails to remedy its default within five (5) days after receipt from the District of notice of such default, the District may terminate the Contractor's right to proceed with work or that portion which the District determines is most directly affected by the default.

The term "default" for purposes of this provision includes, but is not limited to, the performance of work in violation of the terms of the Contract; abandonment, assignment or subletting of the Contract without approval of the District, bankruptcy or appointment of a receiver for Contractor's property; failure to maintain the schedule of work; refusal or failure to maintain the schedule of work; refusal or failure properly to prosecute the work; use of materials, supplies, plant or equipment of improper quality or quantity; refusal or failure to provide proper workmanship; failure to take effective steps to end a prolonged labor dispute; and the performance of the Contract in bad faith.

Upon the District's termination of the Contractor's right to proceed with the work or a portion of it, the District will have the right to complete the work or the portion by whatever means and methods it deems expedient, including the hiring of others on such terms as the District deems advisable.

The expense of completing such work or portion thereof, together with a reasonable charge for managerial and administrative services as certified by the District, will be charged to the Contractor, and the expense so charged will be deducted by the District out of such monies as may be due or may at any time thereafter become due to the Contractor. In case such expense is more than the sum which otherwise would have been payable to the Contractor under the Contract, then the Contractor or its surety or sureties shall promptly pay the amount of such excess to the District, upon notice from the District of the excess so due. The District may, in its sole discretion, withhold all or any part of any progress payments otherwise due to the Contractor until completion and final settlement of the work covered by such notice of default.

43. **Payments.** Unless otherwise stated in the Specifications or Bid forms, the District shall pay the Contractor within thirty (30) days after the District issues a written notice of final acceptance.
44. **Liquidated Damages.** It is agreed by the parties to the Contract that time is of the essence, and in event of delay in completion of the work or the delivery of the supplies, materials or equipment beyond the date set forth in the Contract documents, or beyond authorized extensions thereof, damage will be sustained by the District and that it is or will be impracticable to determine the actual amount of the damage by reason of such delay, and it is, therefore, agreed that the District shall be paid an amount as set forth in the Special Provisions as liquidated damages. If no amount is set forth, Contractor shall be liable for actual damages for each and every calendar day that the time consumed in said completion extends beyond the date herein specified in that the District will suffer by reason of said delay or default. If the delay in delivery is caused by strikes, government controls or other causes beyond the control of the Contractor, an extension of time without liquidated damages liability shall be granted by the District upon a proper showing and finding by the District that the extension is justified.
45. **Insurance Certificates.** Certificates of insurance required by the Special Provisions shall be delivered to the District concurrently with the executed Contract. The District reserves the right to request certified copies of an insurance policy if questions arise.

All required insurance under this Contract shall provide adequate protection for the San Mateo County Harbor District, its Officers, Agents, Representatives and Employees, while



acting in such capacity and their successors or assignees, as they now or as they may hereinafter be constituted singly, jointly or severally, and the Contractor, against all claims, liability damages and accidents of any kind.

46. **Infringement of Patents.** The Contractor agrees that it will, at its own expense, defend all suits or proceedings instituted against the District and pay any award of damages assessed against the District in such suits or proceedings, insofar as the same are based on any claim that the materials or equipment, or any part thereof, or any tool, article or process used in the manufacture thereof, constitutes an infringement of any patent of the United States provided the District gives to the Contractor prompt notice in writing of the institution of the suit or proceeding and permits the Contractor through its counsel to defend the same and gives the Contractor all needed information, assistance and authority to enable the Contractor so to do.
47. **Assignment.** The Contractor shall not assign, transfer, convey, sublet or otherwise dispose of the Contract or its right, title or interest in or to the same, or any part thereof, without previous consent in writing of the General Manager endorsed thereon or attached thereto.
48. **Warranty of Title.** Contractor shall warrant to the District, its successors and assigns, that the title to the material, supplies or equipment covered by the Contract, when delivered to the District or to its successors or assigns, is free from all liens and encumbrances.
49. **Warranty of Fitness.** Contractor hereby warrants that all materials furnished shall meet the requirements and conditions of the Bid documents; shall be fit for the purposes intended and fulfill its design functions; shall be free of all patent and latent defects in design materials, and workmanship and perform satisfactorily.

It is understood and agreed that by acceptance of this warranty and the acceptance of materials or supplies to be manufactured or assembled pursuant to these Specifications, District does not waive any warranty, either expressed or implied in Sections 2312 to 2317, inclusive, of the Commercial Code of the State of California or any products liability of the Contractor as determined by any applicable decision of a court of the State of California or of the United States.

50. **Time of Completion.** The Contractor shall complete all or any designated portion of the work called for under the Contract in all parts and requirements within the time set forth in the Special Provisions.

Time shall be computed starting the first day after the effective date of the Notice to Proceed. The effective date of the Notice to Proceed will be the date stated as such in the Notice to Proceed, provided that in no case will such effective date be earlier than the date of the issuance of such Notice to Proceed.

51. **Or Approved Equal Clause.** In order to establish a basis of quality, certain materials, processes and type of machinery and equipment, or kinds of materials may be specified on the plans or herein, either by description of process or by designating a manufacturer by name or by referring to a brand of product designation, or by specifying a kind of material. It is not the intent of these Specifications to exclude other processes, equipment or materials of equal Value, Utility or Merit which are approved by the District.

52. **Antitrust Claims.** The Contractor's attention is directed to California Government Code Section 4552, which shall be applicable to the Contractor and its subcontractors:

In submitting a Bid to a public purchasing body, the Bidder offers and agrees that if the Bid is accepted, it will assign to the purchasing body all rights, title, and interest in and to all causes of action it may have under Section 4 of the Clayton Act (15 U.S.C. Sec. 15) or under the Cartwright Act (Chapter 2 (commencing with Section 16700) of Part 2 of Division 7 of the Business and Professions Code), arising from purchases of goods, materials, or services by the Bidder for sale to the purchasing body pursuant to the Bid. Such assignment shall be made and become effective at the time the purchasing body tenders final payment to the Bidder.

53. **Environmental and Safety and Health Standards Compliance.** Contractor shall comply with applicable environmental statutes, regulations and guidelines in performing the work under this Contract. The Contractor shall also comply with applicable Occupational Safety and Health standards, regulations and guidelines in performing the work under this Contract.

54. **Equal Employment Opportunity.** In connection with the performance of this Contract, the Contractor shall not discriminate against any employee or an applicant for employment because of race, color, religion, gender, national origin, ancestry, age, marital status, pregnancy, medical condition, disability, or sexual orientation as provided for in Federal, State and local laws in consideration of an award.

The Contractor shall take affirmative action to insure that applicants are employed, and that employees are treated during their employment, without regard to the above factors. Such actions shall include but not be limited to the following: demotion or transfer; recruitment or recruitment advertising; layoff or termination; rates of pay; other forms of compensation; and selection for training, including apprenticeship.

55. **Rights and Remedies of the District.** The rights and remedies of the District provided herein shall not be exclusive and are in addition to any other rights and remedies provided by law or under the Contract.

56. **Qualification Questionnaire.** The Contractor shall submit with its bid documentation showing whether or not the Contractor, any officer of the Contractor, or any employee of the Contractor, has ever been disqualified, removed, or otherwise prevented from bidding on or completing any federal, state or local government project because of a violation of law or safety regulation. For this purpose, Contractor must complete the Bidders Statement of Qualification Questionnaire and Financial Statement with Business Reference.

57. **Bid Protest Procedures.** **FAILURE TO COMPLY WITH ANY OF THE REQUIREMENTS SET FORTH IN THE DISTRICT'S BID PROTEST PROCEDURES MAY RESULT IN REJECTION OF THE PROTEST.**

a. **Protests Based Upon the Specifications.**

- (1) **Pre-Protest Procedures.** Bidders must first utilize any procedures in the specifications for Approved Equals or Requests for Clarifications or Modifications, prior to submitting a protest. If the bidder disagrees with the District's decision on such requests, the bidder may then avail itself of the

bid protest procedures.

- (2) Submission of Protest. Protests based upon restrictive specifications or alleged improprieties in the bidding procedure or contract specifications, which are apparent or reasonably should have been discovered prior to bid opening, shall be filed in writing with the District not later than five calendar days before the bid opening or proposal due date. The protest must clearly specify in writing the grounds and evidence on which the protest is based. If the protestor later raises new grounds or new evidence that reasonably could have been raised, the District will not consider such new grounds or evidence in the determination on the protest. Staff shall respond to the protest with its written determination prior to bid opening or proposal due date. Where the staff determination could affect bid responses, an appropriate extension of the bid opening or proposal due date may be granted.
- (3) Review by the General Manager. If the protest is denied, the bidder may pursue its protest to the General Manager. Within forty-eight (48) hours of receipt of the staff's written determination to deny the protest, the bidder must submit in writing to the General Manager a statement of the reasons for the protest, with supporting evidence, and document that it has exhausted all administrative remedies at the District staff level. The General Manager will issue a written decision prior to the bid opening, which shall be final.

b. Protests Based Upon Contract Award.

- (1) Notice of Staff Recommendation for Award of Contract. Upon conclusion of the bid evaluation for each contract, the District shall send a notice to all bidders of the staff's recommendation for contract award. Such notice shall be sent at least seventy-two (72) hours prior to the Board or Committee meeting, if applicable, at which the recommendation will be considered.
- (2) Submission of Protest; Initial Procedures. Protests based upon alleged improprieties that are not apparent or which could not reasonably have been discovered prior to bid opening, such as disputes over the staff recommendation for contract award, shall be submitted in writing to the District by the deadline specified in the notice from the District advising of the staff's recommendation for award of contract.
- (3) The protest must clearly specify in writing the grounds and evidence on which the protest is based. If the protestor later raises new grounds or new evidence not previously set forth in written submissions that reasonably could have been raised earlier, the District will not consider such new grounds or evidence in the determination on the protest.
- (4) The Deputy Secretary of the District will make best efforts to notify the other bidders of the protest, and the time and place it will be considered by the Board.

c. Proceedings Before the Board. The protestor may appear before the Board to

present evidence in support of its appeal. After consideration of the protestor's evidence, the staff recommendation, and any other relevant information, the Board may determine whether to reject or allow the protest. Upon Board action, a written statement of the reasons therefore shall be included in the record.

The decision of the Board on the protest and the award of contract, if such a decision is made, shall be final.

d. Protests after Contract Award. No protests will be considered after contract award, except for compelling reasons whereby the lateness is due to the District's untimely handling of the protest submission. In no event will the District consider protests filed after contract award due to the neglect of the protestor. Failure to comply with the time periods for filing protests as set forth herein shall be a basis for rejection of the protest.

58. **Air Pollution Control.** The Contractor shall comply with all air pollution control rules, regulations, ordinances and statutes which apply to any work performed pursuant to the Contract, including any air pollution control rules, regulations, ordinances and statutes, specified in Section 11017 of the Government Code. Material to be disposed of shall not be burned, either inside or outside the work site.

59. **Water Pollution Control.** The Contractor shall comply with all water pollution control rules, regulations, ordinances and statutes which apply to any work performed pursuant to this Contract.

The Contractor shall exercise every reasonable precaution to protect streams, lakes, reservoirs, bays, coastal waters and other bodies of water from pollution with fuels, oils, bitumens, calcium chloride and other harmful materials, and shall conduct and schedule its operations so as to avoid or minimize muddying and silting of said waters.

60. **Compliance with Law.**

(a) The Contract documents, and the rights of the parties thereunder, shall be interpreted in accordance with the laws of the State of California.

(b) The Contractor warrants that all operational practices of the Contractor, and all workmanship and material, equipment and articles used in the performance of the work hereunder shall be in accordance with the rules and requirements of the United States Coast Guard in effect at the time of Contractor's submission of Bid. In addition, all safety orders, rules and recommendations of the State of California, Division of Industrial Safety, and the United States Department of Labor, Occupational Safety and Health Administration applicable to the work to be done under this Contract shall be obeyed and enforced by the Contractor.

61. **Discharge of Liens.** The Contractor shall pay all costs and expenses incident to any work performed by it or for its account, and shall not create, incur, suffer or permit to be placed

or imposed any lien or encumbrance or charge in any way arising from any act or omission of the Contractor. The Contractor shall orally or in writing inform all persons dealing with it in performing the work of the provisions of this paragraph.

The Contractor shall immediately discharge or cause to be discharged any lien or right in rem of any kind, other than in favor of the District, and if any such lien or right in rem is not immediately discharged, the District may, after notification to the Contractor, discharge or cause to be discharged such lien or right at the expense of the Contractor.

**CONTRACT NO. 2024-03**  
**Johnson Pier Electric Upgrades**  
**SPECIAL PROVISIONS**

**SAN MATEO COUNTY HARBOR DISTRICT**

**CONTRACT NO. 2024-03  
Johnson Pier Electric Upgrades**

**SPECIAL PROVISIONS**

**Coordination of General Conditions and Instructions for Bidders, Special Provisions, and Technical Specifications.** The General Conditions and Instructions for Bidders, Special Provisions, and Technical Specifications are intended to be complementary and to describe and provide for a complete work. In the event that there are inconsistencies or discrepancies between provisions contained in these components of the Contract Documents, the Special Provisions and Technical Specifications shall govern over the General Conditions and Instructions for Bidders.

**SECTION 1. BID REQUIREMENTS AND CONDITIONS**

- 1.1 **Bid Invited.** The San Mateo County Harbor District (District) invites bids for the Johnson Pier Electric Upgrades, in full accordance with these specifications.
  
- 1.2 **Schedule of Activities.** Listed below is the “Schedule of Activities” which outlines pertinent dates of which Bidders should make themselves aware. These dates may be subject to change.

DATE	ACTIVITY
<b>May 3, 2024 Friday @ 11:00 am</b>	Mandatory Pre-Bid Conference and site visit at Pillar Point Harbor – Harbor Master’s Office
<b>May 15, 2024 Weds @ 4:30 p.m.</b>	Written requests for approved equals/modifications/clarifications are due.
<b>May 22, 2024 Weds @ 4:30 p.m.</b>	District will respond to requests for approved equals.
<b>June 5, 2024 Wednesday @ 2:00 p.m.</b>	Bid Opening San Mateo County Harbor District Office, 504 Avenue Alhambra, 2 <sup>nd</sup> floor, El Granada, CA 94018

- 1.3 **Bid Form.** Bids shall be submitted on the District’s “Bid Form” attached hereto, enclosed in a sealed envelope marked “**CONTRACT NO. 2024-03, Johnson Pier Electric Upgrades**” and plainly endorsed with the Bidder’s name and address. Bids must be received by the Deputy Secretary, San Mateo County Harbor District, at its mailing address PO Box 1449, El Granada, CA 94018, or by courier or personal delivery to 504 Avenue Alhambra, 2<sup>nd</sup> Floor, El Granada, CA 94018 by **June 5, 2024, Wednesday, 2:00 p.m. Pacific Time**, at which time they will be publicly opened and read in the Board Room of said building.

The Total Bid Price shall include all labor, equipment, materials, applicable taxes, delivery charges, warranties, insurance, license fees, bonds, and all other costs necessary for the Johnson Pier Electric Upgrades.

Each Bid Form must be signed on Bid Form page 2 by one or more individuals with authority to bind the Contractor to the bid. Please refer to General Condition 3 and the Bid Form. All bids without the appropriate signature(s) on Bid Form page 2 may be deemed non-responsive and may result in the rejection of the bid. Bidder must submit the three-page Bid Form properly executed.

**1.4 Examination of Contract Documents and Site of Work.** The Bidder shall have examined carefully the Contract Documents. The submission of a Bid shall be conclusive evidence that the Bidder has investigated and is satisfied as to the conditions to be encountered, the character, quality and scope of work to be performed, the quantities of materials to be furnished and the requirements of the Contract Documents.

**1.5 Pre-Bid Conference and Site Visit.** A MANDATORY pre-bid conference and site visit will be held prior to the date of bid opening. District staff will be available to answer general questions pertaining to the solicitation documents and the specifications. Any questions that may require staff research to answer or that will otherwise modify the meaning or intent of this solicitation shall be submitted to the District in writing as described in Special Provision 1.8. The pre-bid conference will take place on **May 3, 2024 at 11:00 am, Pacific Time, in the Pillar Point Harbor – Harbor Master’s Office.**

**1.6 Documents to Accompany Bid.** The bid shall be accompanied by the following:

- (1) The Bidder’s Bond or certified or cashier’s check required by Section 14 of the General Conditions and Section 1.10 of the Special Provisions in an amount equal to at least ten percent (10%) of the proposed Total Bid Price
- (2) List of Subcontractors
- (3) Acknowledgement of Addenda, if any
- (4) Qualification Questionnaire
- (5) Proof of DIR Registration in accordance with Special Provision 5.15
- (6) Non-Collusion Declaration

**1.7 Approved Equals and Qualified Products.** It should be understood that specifying a brand name or specific types of components and/or equipment in these specifications shall not relieve the Bidder from its responsibility to furnish the end product in accordance with the warranty and contractual requirements. The Bidder is responsible for notifying the District of any inappropriate brand names, or types of components and/or equipment that may be called for in these specifications and to propose a suitable substitute for consideration. Unless otherwise specifically provided in the specifications, reference to any equipment, material, article or patented process by trade name, make, or catalog number shall be regarded as establishing a standard of quality and shall not be construed as limiting competition; and a Bidder may, at its option, use any equipment, material, article or process which, in the judgment of the District, is equal to that designated.

The Bidder shall furnish, at its own expense, all test results, technical data, and background information required by the District in making the determination as to whether the proposed equipment, material, article or process is an approved equal. The District shall be the sole



judge as to the comparative equality and suitability of alternative equipment, article, material or process and its decision shall be final.

**1.8 Request for Approved Equals/Questions/Clarifications.** A Bidder may submit to the District requests for approved equals, modifications, or clarifications regarding any requirements, terms, or conditions contained herein. Any such requests must be received in writing to [jmoren@smharbor.com](mailto:jmoren@smharbor.com) by **May 15, 2024, at 4:30 p.m. Pacific Time.** Any requests of approved equals must be fully supported with samples, technical data, test results, or other pertinent information as evidence that the substitute offered is essentially equal or better than that specified in the Contract Documents. The District shall make a determination on each Bidder's request under this procedure in writing. The written determination shall be mailed or otherwise furnished to the Bidder by **May 22, 2024 at 4:30 p.m.** Failure of the District to respond within the time limit shall be deemed to be a denial of request. In the event that a request for an approved equal, modification, or clarification is granted, an addendum detailing the approved equal, modification, or clarification will be mailed or otherwise furnished to all potential Bidders who received bid packets.

**1.9 Single-Bid Response.** In the event of a single-bid response, the District reserves the right to conduct a price and/or cost analysis of the bid to verify that the bid price is fair and reasonable. The Bidder will be expected to cooperate in this process and to submit cost and pricing data to verify that the bid price is fair and reasonable. The right of examination shall extend to all documents necessary to permit adequate evaluation of the cost of the replacement and the prices quoted and shall include the computations and projections used by the Bidder.

Failure to submit the data as requested by the District within ten (10) calendar days of receipt of written notification to the sole offeror shall result in the Bidder being declared non-responsive.

**1.10 Bidder's Bond.** As required by Section 14 of the General Conditions and Instructions for Bidders, the Bidder's Security to be submitted with the Bid shall be in the amount of at least ten (10) percent of the Total Bid Price as specified on the Bid Form.

## **SECTION 2. AWARD OF CONTRACT**

**2.1 Award of Contract.** The award of Contract, if any, will be made within ninety (90) calendar days after the date of bid opening to the lowest responsible Bidder based on the Total Bid Price. Each bid as submitted shall remain in effect for ninety (90) calendar days after the date the bids are opened. No Bidder may withdraw its bid during this time period. The lowest responsive and responsible Bidder shall be determined by comparing and evaluating the Total Bid Price as set forth in the Bid Form. The District reserves the right to reject any and all bids or to waive any irregularities in any bid or in the bidding procedure.

### **2.2 Contract Bonds**

**A. Performance Bond.** The Performance Bond as described in Paragraph 26 of the General Conditions shall be in the amount of one hundred percent (100%) of the total contract price, as awarded by the District. Said bond shall guarantee the Contractor's faithful performance of the Contract and compliance with all terms,

conditions and requirements specified in the Contract Documents and shall remain in full force and effect for a period of twelve (12) months after the District's final acceptance of the Contractor's work in accordance with Special Provision 3.2 hereof. The Contractor shall use the form entitled "Performance Bond" included in the Contract Documents.

- B. Payment Bond.** The Contractor shall provide a payment bond in the amount equal to one hundred percent (100%) of the total contract price and issued by California admitted surety. The payment bond shall provide security for Contractor's full payment to all subcontractors for costs of materials, equipment, supplies, and labor furnished in the course of the performance of the Contract. Full compensation for furnishing the payment bond is included in the total contract price. The Contractor shall use the form entitled "Payment Bond" included in the Contract Documents.

### SECTION 3. CONTRACT PERFORMANCE

- 3.1 General.** The Contractor shall perform all work and undertake all services detailed in the Contract Documents in accordance with the specified requirements, terms and conditions.

- 3.2 Acceptance and Payment.** The Contractor shall notify the District once it has completed all work and services detailed in the Contract Documents in accordance with the specified requirements, terms and condition. Following the Contractor's notification, the District shall undertake a thirty (30)-calendar-day period for inspection. The District will notify the Contractor in writing within said thirty (30) calendar days as to whether the work and services have been accepted.

If the District determines that the work and services are not in conformity with the specification requirements, or that there are defects or deficiencies requiring correction, the District will notify the Contractor of such deficiencies or nonconformity in writing within the aforementioned thirty (30)-day period. The Contractor shall promptly correct or remedy any and all deficiencies or defects noted by the District at no cost to the District. The Contractor shall complete the necessary corrections within fifteen (15) days of the District's notification of deficiencies or nonconformity. At such time as the Contractor has made all necessary corrections to the satisfaction of the District, the District shall issue the Contractor a written notice of final acceptance. In the event the Contractor fails to remedy the deficiencies, the District shall have the right to reject the work and terminate the Contract for breach as provided below in Special Provision Section 3.7, Termination. Alternatively, the District may cause the repair to be made by its own or other forces, whereupon the cost of the repair shall be deducted from sums otherwise due the Contractor.

After final acceptance by the District, the Contractor may thereupon furnish to the District satisfactory evidence that all liens, claims and demands of Subcontractors, laborers and materialmen, arising out of such work, are fully satisfied, and that all of the work is fully released from all liens, claims and demands of whatever kind and nature and whether just or otherwise.

In accordance with Paragraph 43 of the General Conditions, the District shall make payment to the Contractor following the receipt of proper statements or invoices for the work within thirty (30) days of the date of final acceptance of the work by the District. The

acceptance by the Contractor of the final payment, whether such payment be made pursuant to any judgment of any court, or otherwise, shall constitute and operate as a release to the District of any and all claims of the Contractor and liability to the Contractor for anything theretofore done or furnished for or relating to or arising out of this Contract and the work done hereunder, and for any prior act, neglect or default on the part of the District or any of its directors, officers, agents or employees excepting only claims against the District for the amounts deducted or retained in accordance with the terms and provisions of this Contract by law. Should the Contractor refuse to accept the final payment as tendered by the General Manager, it shall constitute waiver of any right to interest thereon.

- 3.3 **Liquidated Damages.** Failure of the Contractor to complete the Work within the time allowed will result in damages being sustained by the District. Such damages are, and will continue to be, impracticable and extremely difficult to determine. For each consecutive calendar day in excess of the time specified for completion of the Work, the Contractor shall pay to the District, or have withheld from monies due it, the sum of \$250 unless otherwise specified in the Special Provisions.

Execution of the Contract shall constitute agreement by the District and Contractor that \$250 per Day is the minimum value of the costs and actual damage caused by the failure of the Contractor to complete the Work within the allotted time. Such sum is liquidated damages and shall not be construed as a penalty, and may be deducted from payments due the Contractor if such delay occurs.

- 3.4 **Time of Performance.** The project will be completed in full no later than 180 days after receiving Notice to Proceed.
- 3.5 **Interference with District Operations.** Any and all work must not interfere with the District's normal operations including operation of Pillar Point Harbor.

- 3.6 **Warranty.** All work, including all installation work or repairs, is guaranteed by the Contractor against failure, damage, defect, or non-compliance with the Contract of any kind for a period of one (1) year from the date of District's final acceptance. The Contractor must furnish a Performance Bond therefor as provided in the Special Provisions. In addition to said guarantee, the District will have the benefits of any manufacturer's or builder's guarantee given by a manufacturer or builder. Where any individual work item is incomplete at the time of acceptance by the District, the guarantee will run from the date of completion of such item. If the Contractor fails to proceed promptly with any repairs as directed by the District, such corrections and repairs shall be affected at the Contractor's expense at such time as the District may determine. The District may deduct the cost of such repairs from any amount owed to the Contractor or require the Contractor to reimburse such costs to the District.

It is understood and agreed that the District does not waive any warranty, either express or implied, in Sections 2312 through 2317, inclusive, of the California Commercial Code, or any liability of the manufacturer or Contractor as may be determined by a decision of the court of the State of California or of the United States.

- 3.7 **Termination.** The District may terminate the Contract for convenience for any reason at any time by giving the Contractor fifteen (15) days' notice thereof. Notice of termination

shall be by Certified Mail. Upon termination for the convenience of the District, the District shall pay the Contractor the allowable costs incurred to the date of termination and those costs deemed reasonably necessary by the District to affect the termination. In the event that the Contractor breaches the terms or violates the conditions of this Contract and does not correct such breaches or violations within ten (10) days following notice thereof from the District, the District may immediately terminate the Contract and shall pay the Contractor only for work performed in full conformance with the specifications to the date of termination, less any costs incurred by the District to repair and complete any remaining work under the Contract. The District reserves the right to pursue any and all remedies available in equity or law in the event the District suffers any damages due to the Contractor's breach of terms or violation of the conditions in this Contract.

- 3.8 Protection of Property.** The Contractor shall exercise every precaution to ensure that no injury or damage occurs to District property as a result of its operations. Should any existing property be damaged by or through any of the Contractor's operations, such injury or damage shall be replaced or repaired immediately by the Contractor, at Contractor's sole cost, in a manner satisfactory to the District.

## **SECTION 4. INSURANCE**

### **4.1 Insurance Requirements**

#### **A. Types of Insurance**

Contractor shall not commence work until proper evidence of insurance coverage of the types and amounts specified in this Section has been provided to District. Contractor shall not violate or permit to be violated any conditions or provisions of said policies of insurance, and at all times shall satisfy the requirements of the insurer for the purpose of maintaining said insurance in effect.

If any claim is made by any third person against Contractor on account of any incident connected to the Contract, Contractor shall promptly report the fact in writing to District, giving full details of the claim.

Any person, firm, or corporation that Contractor authorizes to work upon the District's property, including any Subcontractor, shall be deemed to be Contractor's agent and shall be subject to all applicable terms of this Contract. Prior to the Contractor's start of the work or entry onto the District's property, Contractor agrees to require its Subcontractors to procure and maintain, at Contractor's (or its Subcontractor(s)') sole cost and expense (and to prove to the District's reasonable satisfaction that it remains in effect throughout the performance of the work under this Contract), the kinds of insurance described below. Such insurance must remain in effect throughout the term of this Contract and will be at the sole cost and expense of Contractor (or its Subcontractor(s)).

#### **1. Commercial General Liability Insurance**

The Contractor shall, at its own expense, procure and maintain Commercial General Liability insurance providing bodily injury and property damage

coverage with a combined limit of at least One Million Dollars (\$1,000,000) each occurrence. This insurance shall include but not be limited to premises and operations, contractual liability covering the indemnity provisions contained in this Contract, personal injury, products and completed operations, and broad form property damage, and include a Cross Liability endorsement.

Said Policy shall protect Contractor and District in the same manner as though a separate policy had been issued to each, but nothing in said policy shall operate to increase the insurance company's liability as set forth in its policy beyond the amount or amounts shown or to which the insurance company would have been liable if only one interest had been named as an insured.

2. Business Automobile Liability

Contractor shall, at its own cost and expense, procure and maintain Business Automobile Liability insurance providing bodily injury and property damage with a combined single limit of at least Two Million Dollars (\$2,000,000) per occurrence for all owned, non-owned and hired automobiles. This insurance shall provide contractual liability covering all motor vehicles and mobile equipment to the extent coverage may be excluded from general liability insurance.

3. Workers' Compensation and Employers' Liability Insurance

If Contractor employs any person to perform work in connection with this Contract, Contractor shall procure and maintain at all times during the performance of such work Workers' Compensation Insurance in conformance with the laws of the State of California, and Federal laws where applicable. Employers' Liability Insurance shall not be less than Five Million Dollars (\$5,000,000) for each accident and Five Million Dollars (\$5,000,000) for each disease, with a policy limit of Five Million Dollars (\$5,000,000).

The policy shall contain a waiver of subrogation in favor of the San Mateo County Harbor District and its officers, directors, employees, volunteers, and agents, while acting in such capacity, and their successors and assignees, as they now or as they may hereafter be constituted, singly, jointly, or severally.

4. Protection & Indemnity.

The Contractor shall provide Protection and Indemnity (including crew), Collision Liabilities and Vessel Pollution insurance covering all vessels, barges or other marine equipment that will be used in connection with this project. The limits of liability shall be not less than \$5,000,000.

## General Insurance Requirements

### 5. Acceptable Insurance

All policies will be issued by insurers acceptable to the District. This insurance shall be issued by an insurance company or companies authorized to do business in the State of California with minimum “Best’s” rating of A- and with minimum policyholder surplus of Fifty Million Dollars (\$50,000,000) or a company acceptable to District in its sole discretion. All policies shall be issued in a form satisfactory to the General Manager of the District and shall be issued specifically as primary insurance. Workers’ Compensation coverage requirements may be met with the California State Compensation Fund.

### 6. Procure and Maintain Insurance

Contractor must, at its own cost and expense, procure and maintain at all times during the performance of this Contract, all of the required policies specified above. The failure to procure or maintain the required insurance policies and/or an adequately funded self-insurance program acceptable to the District will constitute a material breach of the Contract.

### 7. Terms of Policies

All insurance specified above shall remain in force until all work to be performed is satisfactorily completed. If the insurance is provided on a claims-made basis it must remain in force for the entire term of the Contract and a minimum of three (3) years thereafter.

### 8. Self-Insurance

Upon evidence of financial capacity satisfactory to the District and Contractor’s agreement to waive subrogation against the District respecting any and all claims that may arise, the Contractor's obligations hereunder may be satisfied in whole or in part by adequately funded self-insurance.

### 5) Deductibles and Retentions

The Contractor shall be responsible for payment of any deductible or retention on the Contractor’s policies without right of contribution from the District. Deductible and retention provisions shall not contain any restrictions as to how or by whom the deductible or retention is paid. Any deductible or retention provision limiting payment to the Named Insured is unacceptable.

In the event that the policy of the Contractor or any subcontractor contains a deductible or self-insured retention, and in the event that the District seeks coverage under such policy as an additional insured, the Contractor shall satisfy such deductible or self-insured retention to the extent of loss covered

by such policy for a lawsuit arising from or connected with any alleged act or omission of the Contractor, subcontractor, or any of their officers, directors, employees, agents, or suppliers, even if the Contractor or subcontractor is not a named defendant in the lawsuit.

**B. Evidence of Insurance and Endorsements**

Prior to commencing of work or entering onto the District's property, Contractor shall file a Certificate of Insurance with the District evidencing the foregoing coverages, including the following endorsements:

1. The insurance company(ies) issuing such policy(ies) will provide at least thirty (30) days' notice to the District of cancellation or non-renewal.
2. That the policy(ies) is primary insurance and the insurance company(ies) providing such policy(ies) shall be liable thereunder for the full amount of any loss or claim that Contractor is liable for under this Section, up to and including the total limit of liability, without right of contribution from any other insurance maintained or which may be maintained by the San Mateo County Harbor District.
3. Such insurance shall include as additional insureds the San Mateo County Harbor District, and its respective directors, officers, employees, and agents while acting in such capacity, and their successors or assignees, as they now or as they may hereafter be constituted, singly, jointly, or severally.
4. The policy must also contain either a Cross Liability endorsement or Severability of Interests Clause and stipulate that inclusion of the District as an additional insured will not in any way affect the District's rights as respects any claim, demand, suit or judgment made, brought, or recovered against the Contractor. Said policy shall protect Contractor and the District in the same manner as though a separate policy had been issued to each, but nothing in said policy shall operate to increase the insurance company's liability as set forth in its policy beyond the amount or amounts shown or to which the insurance company would have been liable if only one interest had been named as an insured.

**C. Consequence of Lapse**

Should any required insurance not be procured or lapse during the term of this Contract, requests for payment originating after such lapse will not be processed until the District receives satisfactory evidence of reinstated coverage as required by the Contract. If insurance is not reinstated, the District, may, at its sole option, terminate this Contract effective on the date of such lapse of insurance.

## SECTION 5. PUBLIC WORKS PROVISIONS

### 5.1 Labor Compliance Requirements

In the performance of this Contract, Contractor's attention is directed to the following requirements of the Labor Code:

- A. Hours of Labor. Eight hours labor constitutes a legal day's work. Contractor shall forfeit, as penalty to District, \$25 for each worker employed in the performance of the Contract by Contractor or by any subcontractor under it for each calendar day during which such worker is required or permitted to work more than eight hours in any one day and 40 hours in any one calendar week in violation of the provisions of the California Labor Code and in particular, Sections 1810 to 1815, inclusive. Work performed by employees of the Contractor in excess of eight hours per day and 40 hours during any one week shall be permitted upon compensation for all hours worked in excess of eight hours per day at not less than one-and-one-half times the basic rate of pay, as provided in Section 1815.
- B. Prevailing Wages. Contractor shall comply with California Labor Code Sections 1770 to 1780, inclusive. In accordance with Section 1775, the Contractor shall forfeit as a penalty to District an amount as determined by the Labor Commissioner not to exceed \$200 for each calendar day or portion thereof for each worker paid less than stipulated prevailing wage rates for such work or craft in which such worker is employed for any work done under the contract by him or by any subcontractor under it in violation of the revisions of the Labor Code and in particular, Labor Code Sections 1770 to 1780, inclusive. In addition to said penalty and pursuant to Section 1775, the difference between such stipulated prevailing wage rates and the amount paid to each worker for each calendar day or portion thereof for which each worker was paid less than the stipulated prevailing wage rate shall be paid to each worker by Contractor. Pursuant to the provisions of Section 1773 of the Labor Code, the District has obtained the general prevailing rate of per diem wages and the general prevailing rate for holiday and overtime work applicable to the work to be done from the Director of the Department of Industrial Relations. Copies of the prevailing wage rates are on file at the District and are available for review upon request. Pursuant to §1773.2 of the Labor Code, the Contractor shall post general prevailing wage rates at a prominent place at the site of the work.
- C. Payroll Records. Contractor and each subcontractor shall submit electronic certified payroll records to the California Labor Commissioner in the manner and format set forth in California Labor Code section 1771.4.

The Contractor's attention is directed to the following provisions of Labor Code Section 1776. The Contractor shall be responsible for the compliance with these provisions by its subcontractors.

- (a) Each contractor and subcontractor shall keep an accurate payroll record, showing the name, address, social security number, work classification, straight time and overtime hours worked each day and week, and the actual per diem wages paid to each journeyman, apprentice, worker, or other



employee employed by him or her in connection with the public work.

- (b) The payroll records enumerated under subdivision (a) shall be certified and shall be available for inspection at all reasonable hours at the principal office of the Contractor on the following basis:
  - (i) A certified copy of an employee's payroll record shall be made available for inspection or furnished to such employee or his or her authorized representative on request.
  - (ii) A certified copy of all payroll records enumerated in subdivision (a) shall be made available for inspection or furnished upon request to the District, the Division of Labor Standards Enforcement and the Division of Apprenticeship Standards of the Department of Industrial Relations.
  - (iii) A certified copy of all payroll records enumerated in subdivision (a) shall be made available upon request to the public for inspection or copies thereof made; provided, however, that a request by the public shall be made through either the District, the Division of Apprenticeship Standards or the Division of Labor Standards Enforcement. If the requested payroll records have not been provided pursuant to paragraph (2), the requesting party shall, prior to being provided the records, reimburse the costs of preparation by the Contractor, subcontractor and the entity through which the request was made. The public shall not be given access to such records at the principal office of the Contractor.
- (c) Unless required to be furnished directly to the Labor Commissioner in accordance with Labor Code Section 1771.4(3)(b), the certified payroll records shall be on forms provided by the Division of Labor Standards Enforcement or shall contain the same information as the forms provided by the Division.
- (d) The Contractor shall file a certified copy of the records enumerated in subdivision (a) with the entity that requested such records within ten (10) days after receipt of a written request.
- (e) Any copy of records made available for inspection as copies and furnished upon request to the public or the District, the Division of Apprenticeship Standards or the Division of Labor Standards Enforcement shall be marked or obliterated in such a manner as to prevent disclosure of an individual's name, address and social security number. The name and address of the Contractor shall not be marked or obliterated.
- (f) The Contractor shall inform the District of the location of records enumerated under subdivision (a), including the street address, city and county, and shall, within five working days, provide a notice of a change of location and address. In the event of noncompliance with the requirements of this Section, the Contractor shall have ten (10) days in which to comply

subsequent to receipt of written notice specifying in what respects such contractor must comply with this Section. Should noncompliance still be evident after such 10-day period, the Contractor shall, as a penalty the State or the District, forfeit One-Hundred Dollars (\$100) for each calendar day, or portion thereof, for each worker, until strict compliance is effectuated. Upon the request of the Division of Apprenticeship Standards or the Division of Labor Standards Enforcement, such penalties shall be withheld from progress payments then due. The penalties specified in subdivision (g) of Labor Code Section 1776 for noncompliance with the provisions of said Section 1776 may be deducted from any monies due or which may become due to the Contractor.

- (g) The Contractor and each subcontractor shall preserve their payroll records for a period of three (3) years from the date of completion of the Contract.
- D. Labor Non-discrimination. Attention is directed to Section 1735 of the Labor Code which provides that Contractor shall not discriminate against any employee or applicant for employment because of race, religious creed, color, national origin, ancestry, physical disability, mental disability, medical condition, genetic information, marital status, sex, gender, gender identity, gender expression, age, sexual orientation, or military and veteran status of any person, except as provided in Section 12940 of the Government Code. Contractor further agrees to include a similar provision in all subcontracts, except subcontracts for standard commercial supplies or raw materials.
- E. Apprentices. The Contractor and all subcontractors shall comply with the requirements of California Labor Code sections 1777.5, 1777.6 and 1777.7 regarding the employment of apprentices.

## 5.2 **Prohibition Against Contracting with Debarred Subcontractors**

Contractor is prohibited from performing work on a public works project with a subcontractor who is ineligible to perform work on the public works project pursuant to Section 1777.1 or 1777.7 of the Labor Code.

## 5.3 **Use of Subcontractors**

Contractor shall not subcontract any work to be performed by it under this Agreement without the prior written approval of the Agency. Contractor shall be solely responsible for reimbursing any subcontractors and the Agency shall have no obligation to them. Attention is directed to the requirements of Section 4100 to 4113, inclusive of the California Public Contract Code which may be applicable to the work covered by this section of the Agreement. Each Contractor shall list the name and business address of each subcontractor to whom the Contractor proposes to subcontract a portion of the work in an amount in excess of one-half of one percent (0.5%) of the Total Contract Price, along with a description of the portion of the work which shall be done by each subcontractor, by executing the "List of Subcontractors" form attached to this Contract.

### **Prompt Payment to Subcontractors**

Pursuant to Business and Professions Code Section 7108.5, the Contractor shall pay each first tier Subcontractor under this Contract for satisfactory performance of work under its subcontract no later than 7 days from the Contractor's receipt of payment from the District for such work. The Contractor shall require each first tier Subcontractor to make payments to lower tier Subcontractors in a similar manner. The District shall have no obligation to pay or to verify the payment of money to any Subcontractor, except as may otherwise be required by law.

The Contractor, not the District, shall be solely responsible for payment to Subcontractors at any tier for any amounts owing from the Contractor. All such Subcontractors agree that they shall have no claim and shall take no action against the District or its officers, directors, employees or sureties, for non-payment by the Contractor.

### **5.4 Prompt Payment**

The District will make progress payments within thirty (30) days after receipt of an undisputed and properly submitted progress payment invoice pursuant to Section 20104.50 of the Public Contract Code. No such payment will be made when, in the judgment of the Engineer, (a) the work is not proceeding in accordance with the provisions of the Contract; (b) the Contractor is not complying with the requirements of the Contract; or (c) when the total value of the work done as shown on the invoice does not exceed Three Hundred Dollars (\$300.00). No such invoice or payment will be construed to be an acceptance of any work or materials. Before any progress payment or the final payment is made, the Contractor may be required to submit satisfactory evidence that he is not delinquent in payments to its employees, subcontractors, suppliers or other creditors for labor and materials incorporated into the work. Pursuant to Public Contract Code Section 20104.50, if the District fails to make a progress payment in a timely manner, it shall pay interest to the Contractor at the legal rate set forth in Section 685.010(a) of the California Code of Civil Procedure.

### **5.5 Non-Collusion Declaration**

Pursuant to Public Contract Code section 7106, Contractor shall execute a Non-Collusion Declaration, in a form provided by the Agency, which is attached and incorporated herein.

### **5.6 Third-Party Claims**

Pursuant to Public Contracts Code Section 9201, the District shall have full authority to compromise or otherwise settle any claim relating to the Agreement at any time. The District will provide for timely notification to the Contractor of the receipt of any third-party claim, relating to the Agreement. Notice shall be in writing and will be provided within thirty (30) days. The District shall be entitled to recover its reasonable costs incurred in providing such notification.

### **5.7 Claims Procedures**

Compliance with all change order procedures is a prerequisite to filing a Public Contract Code Claim pursuant to this section. Claims must be submitted no later than (a) 30 days after change order procedures are complete and the Contractor has notified the General

Manager in writing that the work is being performed, or that the determination direction is being complied with, under protest as per General Conditions 30 and 31 or (b) 30 days after the occurrence of the event giving rise to the claim.

In accordance with the procedures set forth in Public Contract Code sections 9204 and 20104-20104.6, a Contractor may submit a claim by registered or certified mail with return receipt requested, for one or more of the following: (a) a time extension, including, without limitation, for relief from damages or penalties for delay assessed by the District; (b) payment by the District of money or damages arising from work done by, or on behalf of, the Contractor pursuant to this contract and payment for which is not otherwise expressly provided or to which the Contractor is not otherwise entitled; or (c) payment of an amount that is disputed by the District.

The Contractor shall furnish reasonable documentation to support the claim, including but not limited to: 1) a clear, concise recital of the basis upon which the claim is asserted, including a designation of the provisions of the Contract Documents upon which the claim is based, 2) a statement as to the amount of time and/or compensation sought pursuant to the claim; 3) whether the Contractor's claim arises from an ongoing occurrence, and if so a description of the specific Work activities affected by the claim, 4) a time impact analysis in the event that Contractor requests a time extension, 5) full and complete cost records supporting the amount of any claim for additional compensation, and 6) a notarized certification by the Contractor as follows: "Under the penalty of law for perjury or falsification and with specific reference to the California False Claims Act, Government Code Section 12650 et seq., the undersigned hereby certifies that the information contained herein is a true, accurate and complete statement of all features relating to the claim asserted." Failure by the Contractor to provide sufficient documentation will result in denial of the claim. The District reserves the right to request additional documentation, or clarification of the documentation provided.

Upon receipt of a claim, the District will conduct a reasonable review and provide a written statement to the Contractor identifying what portion of the claim is disputed and what portion is undisputed within 45 days of receipt of the claim. The District and Contractor may, by mutual agreement, extend the 45day time period. For any undisputed portion of a claim, the District must make payment within 60 days of its issuance of the written statement.

If the Contractor disputes the District's written statement, or if the District fails to respond, the Contractor may demand an informal conference to meet and confer for settlement of the issues in dispute. The District will then schedule the meet and confer conference within 30 days of the demand. Within 10 business days following the meet and confer conference, the District will provide a written statement identifying the portion of the claim that remain in dispute. Any payment due on an undisputed portion of the claim will be made within 60 days of the meet and confer conference.

After the meet and confer conference, any disputed portion of the claim shall be submitted to non-binding mediation. Alternatively, upon receipt of a claim, the parties may mutually agree to waive, in writing, mediation and proceed directly to the commencement of a civil action or binding arbitration, as applicable. If mediation is unsuccessful, the parts of the claim that remain in dispute shall be subject to applicable procedures set forth below.

Failure of a public entity to respond to a claim within the time periods described above shall result in the claim being deemed rejected in its entirety. Additionally, amounts not paid in a timely manner shall bear interest at 7 percent per year.

In the event that the mediation is unsuccessful, Contractor must file a government claim pursuant to Government Code section 910 et seq. in order to initiate a civil action.

In any civil action filed to resolve claims, the court shall submit the matter to nonbinding mediation within 60 days following the filing or responsive pleading, provided that the parties have not already participated in mediation of the claim as outlined above. If the matter remains in dispute after nonbinding mediation, the court shall submit the matter to judicial arbitration pursuant to Code of Civil Procedure section 1141.10 et seq. If the matter remains in dispute after judicial arbitration, the District or the Contractor may request a trial de novo.

#### **5.8 Contractor's License Requirements**

Contractor and any approved subcontractors shall hold such current and valid Contractor's Licenses as required by California Law and as applicable for the work to be performed under this contract. **Contractor must hold a Class A Contractor License.** License must be valid and active at time of award or project.

#### **5.9 Payment of Workers' Compensation**

Contractor shall sign and file with the Agency the following certification prior to performing the work of the Agreement:

"I am aware of the provisions of Section 3700 of the Labor Code which requires every employer to be insured against liability for workers' compensation or to undertake self-insurance in accordance with the provisions of that code, and I will comply with such provisions before commencing the performance of the work of this Agreement."

#### **5.10 Examination and Audit of Records**

Pursuant to Government Code Section 8546.7, Contractor shall retain all project-related records for a period of 3 years after final payment on this Agreement, which shall be subject to audit or inspection by the Agency or the State Auditor during this period.

#### **5.11 Anti-Trust Claim Assignment**

Pursuant to Public Contract Code 7103.5, the contractor offers and agrees to assign to the District all rights, title, and interest in and to all causes of action it may have under Section 4 of the Clayton Act (15 U.S.C. Sec. 15) or under the Cartwright Act (Chapter 2 (commencing with Section 16700) of Part 2 of Division 7 of the Business and Professions Code), arising from purchases of goods, services, or materials pursuant to this Contract. This assignment shall be made and become effective at the time the District tenders final payment to the Contractor, without further acknowledgment by the parties.

#### **5.12 Utility Relocation**

If applicable, pursuant to California Government Code Section 4215, if during the course

of the work the Contractor encounters utility installations which are not shown or indicated in the contract plans or in the specifications or which are found in a location substantially different from that shown, and such utilities are not reasonably apparent from visual examination of the work site, then it shall promptly notify the District in writing. Where necessary for the work of the Contract, the District will amend the contract to adjust the scope of work and the compensation to allow the Contractor to make such adjustment, rearrangement, repair, removal, alteration, or special handling of such utility, including repair of the damaged utility. If the Contractor fails to give the notice specified above and thereafter acts without instructions from the District, then it shall be liable for any or all damage to such utilities or other work of the Contract which arises from its operations subsequent to the discovery, and it shall repair and make good such damage at its own cost.

### **5.13 Public Works Registration**

The Contractor must be registered with the California Department of Industrial Relations pursuant to Labor Code Section 1725.5. **BIDDERS MUST SUBMIT PROOF OF CONTRACTOR REGISTRATION WITH THE DIR IN THE FORM OF A HARD COPY OF THE RELEVANT PAGE OF THE DIR'S DATABASE FOUND AT: <https://efiling.dir.ca.gov/PWCR/Search>.**

This Contract is subject to monitoring and enforcement by the DIR pursuant to Labor Code Section 1771.4. The Contractor must post job site notices, as prescribed by regulation. The Contractor shall furnish the records specified in Labor Code Section 1776 directly to the Labor Commissioner, monthly in a format prescribed by the Labor Commissioner.

### **5.14 Compliance with All Applicable Laws**

The Contractor shall comply with all the applicable requirements of federal, state and local laws, statutes, and ordinances relative to the execution of the Construction Work. In the event Contractor fails to comply with these requirements, the District may stop any Construction Work until such noncompliance is remedied. No part of the time lost due to any such cessation of the Construction Work shall be made the subject of a claim for an extension of time or increase in the compensation.

### **5.15 Permit Compliance**

The Contractor shall comply with all the applicable requirements of federal, state and local permits relative to the execution of the Construction Work. In the event Contractor fails to comply with these requirements, the District may stop any Construction Work until such noncompliance is remedied. No part of the time lost due to any such cessation of the Construction Work shall be made the subject of a claim for an extension of time or increase in the compensation.

### **5.16 Iran Contracting Act**

The undersigned Bidder certifies that it is not, at the time of bidding, on the California Department of General Services (DGS) list of persons determined to be engaged in investment activities in Iran or otherwise in violation of the Iran Contracting Act of 2010 (Public Contract Code Section 2200-2208).

### **5.17 Safety Requirements**

The Contractor shall promptly and fully comply with and carry out, and shall without separate charge therefore to the District, enforce compliance with the safety and first aid requirements prescribed by applicable State and Federal laws and regulations, rules and orders and as may be necessary to ensure that all Construction Work shall be done in a safe manner and that the safety and health of the employees, agents and the people of local communities is safeguarded. Compliance with the provisions of this Section by subcontractors shall be the responsibility of the Contractor. All installed, dismantled, and removed material, equipment and facilities, without separate charge therefore to the District, shall fully conform with all applicable State and Federal safety laws, rules, regulations and orders and it shall be the Contractor's responsibility to furnish only such material, equipment and facilities.

### **5.18 Retention on Progress Payments**

If the Contract utilizes progress payments, five percent (5%) will be deducted from each progress payment and held in retention by the District. The remainder less any other deductions taken in accordance with this article will be paid to the Contractor as progress payments. The Contractor acknowledges and agrees that, pursuant to Public Contract Code section 7200, the percentage of retention amounts withheld by the Contractor from its Subcontractors may not exceed the percentage withheld by the District from the Contractor as specified herein.

Contractor shall release retention to a Subcontractor within 30 days of the Subcontractor satisfactorily completing all required work. Upon satisfactory completion of a Subcontractor's work, including provision of appropriate releases, certificates, evidence of the Subcontractor's compliance with all applicable requirements of the Contract Documents, and all other documents as may be required by the Contractor and the District to close-out the subcontract, the Contractor may submit an application to the District for the release of the portion of the retention attributed to the Subcontractor's work. The Contractor's application shall certify that the Subcontractor has:

- a) Completed all work required to be performed under its subcontract;
- b) The amount withheld by the Contractor under the subcontract; and
- c) That the Subcontractor has provided all backup information, stop payment notice, and lien releases required to close-out the subcontract.

Within 7 days following receipt of payment from the District for the completed Subcontractor Work, the Contractor shall release all monies withheld as retention from the Subcontractor, even if the Work to be performed by the Contractor or other Subcontractors is not completed and has not been accepted. The Contractor shall, by appropriate agreement with each Subcontractor, require each first tier Subcontractor to make payments to lower tier subcontractors in a similar manner.

### **5.19 Release of Retention**

Upon the District's issuance of Notice of Final Acceptance the District will release the

amount retained.

## **5.20 Securities in Lieu of Retention**

Pursuant to Public Contract Code Section 22300, the successful Bidder may submit Securities in lieu of retention payments by the District. Upon Contractor's request, the District will make payment of funds withheld from progress payments, pursuant to the requirements of California Public Contract Code Section 22300, if Contractor deposits in escrow with the District or with a bank acceptable to the District, securities eligible for investment under California Government Code Section 16430, bank or savings and loan certificates of deposit, interest bearing demand deposit accounts, standby letters of credit, or any other security mutually agreed to by Contractor and the District, upon the following conditions:

- (1) Contractor shall bear the expenses of the District and the escrow agent in connection with the escrow deposit made.
- (2) Securities or certificates of deposit to be placed in escrow shall be of a value at least equivalent to the amounts of retention to be paid to Contractor pursuant to this article.
- (3) Contractor shall enter into an escrow agreement satisfactory to the District, which agreement shall be substantially similar to the form provided in California Public Contract Code Section 22300.
- (4) Contractor shall obtain the written consent of the surety to such agreement.

## **SECTION 6. HAZARDOUS CHEMICALS AND WASTES**

For the purposes of this Section only, the term "claims" shall include (a) all notices, orders, directives, administrative, or judicial proceedings, fines, penalties, fees, or charges imposed by any governmental agency with jurisdiction, and (b) any claim, cause of action, or administrative or judicial proceeding brought against the District, its directors, or employees, or for any loss, cost (including reasonable attorney's fees), damage, or liability, sustained or suffered by any person or entity, including the District. The Contractor shall bear full and exclusive responsibility for any release of hazardous or nonhazardous chemicals or substances during the course of performance of this Contract. The Contractor shall immediately report any such release to the District. The Contractor shall be solely responsible for all claims and expenses associated with the response to, removal and remediation of the release, including, without limit, payment of any fines or penalties levied against the District by any agency as a result of such release and shall hold harmless, indemnify, and defend the District from any claims arising from such release.

If the performance of the work outlined by these Contract specifications creates any hazardous wastes, those wastes shall be properly disposed of according to federal, state, and local laws, at the expense of the Contractor. The Contractor shall dispose of the wastes under its own EPA generator number. In no event shall the District be identified as the generator. The Contractor shall notify the District of any such hazardous wastes and the District reserves the right to a copy of any test conducted on the wastes and, at its cost, to perform additional tests or examine those wastes, prior to disposition. The Contractor shall hold harmless, indemnify, and defend the District from any claims arising from the disposal of the hazardous wastes, regardless of the absence of negligence or other malfeasance by the Contractor.





**Contract No. 2024-03**

**Johnson Pier Electric Upgrades**

**TECHNICAL SPECIFICATIONS**

# PILLAR POINT JOHNSON PIER ELECTRIC UPGRADES

## PILLAR POINT HARBOR SAN MATEO COUNTY HARBOR DISTRICT SAN MATEO COUNTY, CALIFORNIA

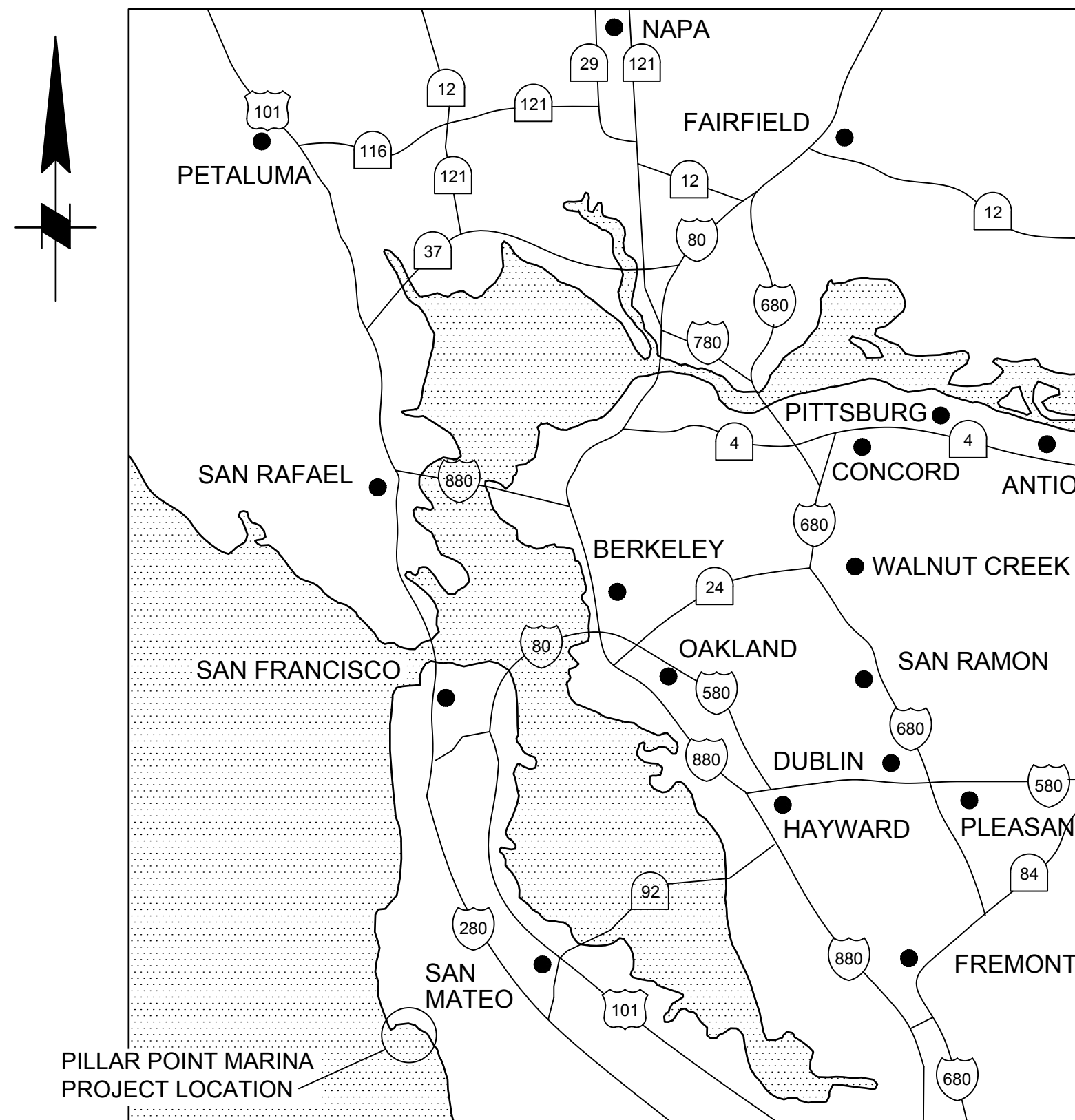

VICINITY MAP  
NTS



LOCATION MAP  
NTS

SHEET INDEX		
SHEET NO.	DRAWING NUMBER	TITLE
1	GE01	COVER SHEET AND DRAWING INDEX
2	GE02	GENERAL NOTES & ABBREVIATIONS
3	GE03	EXISTING SITE PLAN
4	EP01	ELECTRICAL PLAN, LEGEND AND NOTES
5	EP41	ENLARGED ELECTRICAL EQUIPMENT LAYOUT
6	EP51	ELECTRICAL DETAILS (1 OF 2)
7	EP52	ELECTRICAL DETAILS (2 OF 2)
8	EP61	SINGLE LINE DIAGRAM

File: C:\Users\johanson\OneDrive\Documents\CADD\_Activity\San Mateo Harbor District\9673-09\_Pillar Point\9673-09\_Pillar Point.dwg, 4/10/2024 4:11 PM by: CHN, JSTN, Saved: 4/10/2024 3:19 PM by: CHN



**SAN MATEO COUNTY HARBOR DISTRICT**  
504 Avenue Alhambra, 2nd Floor  
El Granada, CA 94018  
(650) 741-9163

REVISION	DESCRIPTION	BY	DATE



2185 N. CALIFORNIA BLVD.  
SUITE 500  
WALNUT CREEK, CA 94596

SAN MATEO COUNTY HARBOR DISTRICT  
JOHNSON PIER ELECTRIC UPGRADES

DATE 4-9-2024

SHEET 1 OF 8

DSGN	DJS	DR	RJC	CHK	KK
JOB NO.	9673-09	SUBMITTED BY	BRAD PORTER	TITLE	PROJECT MANAGER

COVER SHEET AND DRAWING INDEX

GE01

**GENERAL NOTES**

1. GENERAL CONDITIONS:

- A. UNDER THIS SECTION THE CONTRACTOR SHALL PROVIDE ALL LABOR, MATERIAL, EQUIPMENT, APPURTENANCES, SERVICES AND SUPERVISION FOR A COMPLETE ELECTRICAL SYSTEM AS SHOWN ON THE DRAWING. ALL MATERIAL AND EQUIPMENT SHALL BE WORKED INTO A COMPLETE, CONVENIENT, AND ECONOMICAL SYSTEM OR SYSTEMS. ALL APPARATUS, PARTS, MATERIAL, AND ACCESSORIES WHICH ARE NECESSARY TO ACCOMPLISH THIS RESULT SHALL BE PROVIDED. MANUFACTURER'S INSTRUCTIONS, WRITTEN OR OTHERWISE, SHALL BE FOLLOWED, UNLESS SUPERSEDED HERE IN. ALL ITEMS SHOWN ARE NEW AND SHALL BE PROVIDED BY THE CONTRACTOR UNLESS SPECIFICALLY INDICATED OTHERWISE.
- B. PROVIDE IS DEFINED TO MEAN THAT THE CONTRACTOR SHALL FURNISH, INSTALL, ADJUST, TEST AND INTEGRATE INTO A COMPLETE SYSTEM THE ITEM INDICATED. INCLUDING ALL HARDWARE WIRING, AND MISCELLANEOUS ITEMS AS NECESSARY FOR A COMPLETE AND OPERATIONAL SYSTEM.
- C. CONTRACTOR SHALL GIVE REQUIRED NOTICES, OBTAIN NECESSARY PERMITS, AND PAY PERMIT FEES.
- D. THE DRAWINGS INDICATE DIAGRAMMATICALLY THE EXTENT OF THE WORK. MINOR VARIATIONS IN LOCATION OF EQUIPMENT SHALL BE MADE UPON WRITTEN APPROVAL OF THE ENGINEER AT NO ADDITIONAL CHARGE.
- E. ALL DIMENSIONS AND ELEVATIONS NOTED ARE ENGLISH UNITS UNLESS OTHERWISE NOTED.
- F. COOPERATE AND COORDINATE THE WORK OF THIS DIVISION WITH OTHER TRADES.
- G. PREPARE AND COORDINATE THE SCHEDULE OF CONSTRUCTION OPERATIONS WITH SMCHD OPERATIONS OF PILLAR POINT MARINA. OPERATIONS OF FISH BUYERS AND BOAT OFFLOADING SHALL BE MAINTAINED DURING PEAK FISHING SEASONS WITH MINIMAL DISRUPTION.
- H. PROVIDE TO THE HARBORMASTER WORK SCHEDULES FOR COORDINATION OF TEMPORARY BOAT RELOCATION WITHIN THE PROJECT AREA. THE HARBORMASTER WILL BE RESPONSIBLE FOR TIMELY NOTIFICATION OF THE TENANTS AND MOVEMENT OF THE BOATS.
- I. VERIFY THE LOCATION OF ALL EXISTING UTILITIES BEFORE BEGINNING ANY DEMOLITION AND CONSTRUCTION OPERATIONS.
- J. DEMOLITION OF EXISTING FEATURES SHALL BE LIMITED TO THE ITEMS SHOWN ON THE PLANS AND DESCRIBED IN THE SPECIFICATIONS. REPAIR AND/OR REPLACE EXISTING FEATURES TO REMAIN THAT ARE DAMAGED BY CONSTRUCTION OPERATIONS, TO THE SATISFACTION OF THE SMCHD AT THE CONTRACTOR'S EXPENSE.
- K. CONTRACTOR TO BE RESPONSIBLE FOR COORDINATION WITH ALL UTILITY SERVICES/PROVIDERS WITHIN THE PROJECT BOUNDARY. THE CONTRACTOR SHALL BE RESPONSIBLE FOR REPAIRING ALL DAMAGE INCURRED TO UTILITIES, TO THE SATISFACTION OF THE SMCHD AT THE CONTRACTOR'S EXPENSE.
- L. CONTACT SMCHD IMMEDIATELY UPON FINDING ANY FIELD CONDITIONS THAT CONFLICT WITH THE INFORMATION ON THESE DRAWINGS. ALL FIELD ADJUSTMENTS MUST BE APPROVED BY SMCHD BEFORE CONSTRUCTION OF SAID ADJUSTMENTS. FAILURE TO DO SO WILL RESULT IN THE CONTRACTOR ASSUMING FULL RESPONSIBILITY FOR ANY REQUIRED REVISIONS OR FIELD MODIFICATIONS, AS DIRECTED BY SMCHD, AT NO ADDITIONAL COST.
- M. CONTRACTOR TO BE RESPONSIBLE FOR CONSTRUCTION SITE SECURITY FOR THE DURATION OF THE CONTRACT PERIOD AND SHALL REFER TO THE SPECIFICATIONS FOR ADDITIONAL INFORMATION AND REQUIREMENTS.
- N. CONTRACTOR TO BEAR RESPONSIBILITY FOR FURNISHING, INSTALLING AND MAINTAINING ALL WARNING SIGNS AND DEVICES NECESSARY TO SAFEGUARD THE GENERAL PUBLIC AND THE WORK, AND FOR PROVIDING PROPER AND SAFE ROUTING OF THE BOAT, VEHICULAR AND PEDESTRIAN TRAFFIC DURING THE PERFORMANCE OF THE WORK. THIS REQUIREMENT SHALL APPLY CONTINUOUSLY AND SHALL NOT BE LIMITED TO WORKING HOURS. THE USE OF FLAGGERS, BARRICADES AND CONSTRUCTION SIGNING SHALL COMPLY WITH THE SAN MATEO COUNTY HARBOR DISTRICT'S STANDARD SPECIFICATION; BUOYS, LIGHTS OR OTHER NAVIGATION AIDS SHALL COMPLY WITH THE U.S. COAST GUARD REQUIREMENTS.
- O. CONTRATOR SHALL KEEP THE PROJECT SITE IN A NEAT AND ORDERLY CONDITION, FREE OF RUBBISH AND DEBRIS, AT ALL TIMES.
- P. ALL WORK SHOWN IS NEW UNLESS NOTED AS EXISTING (E).
- Q. ALL PIERS, DOCKS, AND EQUIPMENT SHALL COMPLY WITH NEC ARTICLE 555 AND NFPA 303.
- R. PROVIDE SUPPORT FOR ALL ELECTRICAL EQUIPMENT TO COMPLY WITH THE SEISMIC REQUIREMENTS OF THE INTERNATIONAL BUILDING CODE AND ALL LOCAL ORDINANCES.
- S. THE LATEST EFFECTIVE PUBLICATIONS OF THE FOLLOWING STANDARDS, CODES, ETC. FORM A PART OF THESE SPECIFICATIONS:

- ALL STATE AND LOCAL BUILDING CODES INCLUDING FLORIDA BUILDING CODE 2017, 6TH EDITION.
- SERVICE RULES AND REGULATIONS OF THE LOCAL ELECTRIC UTILITY COMPANY.
- AMERICAN NATIONAL STANDARDS INSTITUTE (ANSI).
- ASTM INTERNATIONAL (ASTM).
- BUILDING INDUSTRY CONSULTING SERVICE INTERNATIONAL (BICSI).
- INTERNATIONAL BUILDING CODE (IBC), 2015 EDITION.
- INTERNATIONAL FIRE CODES (IFC).
- INSTITUTE OF ELECTRICAL AND ELECTRONIC ENGINEERS (IEEE).
- NATIONAL ELECTRICAL MANUFACTURER'S ASSOCIATION (NEMA).
- NATIONAL FIRE PROTECTION ASSOCIATION (NFPA).
- NATIONAL ELECTRICAL CODE (NEC), 2014 EDITION.
- TELECOMMUNICATIONS INDUSTRY ASSOCIATION (TIA).
- UNDERWRITERS LABORATORIES (UL).
- ILLUMINATING ENGINEERING SOCIETIES (IES).

- H. SUBSTANTIAL COMPLETION: UPON COMPLETION OF THE ENTIRE WORK, THE CONTRACTOR SHALL PERFORM SUCH TESTS AS REQUIRED BY THE ENGINEER. THE ENGINEER SHALL BE GIVEN 48 HOURS NOTICE BEFORE TESTS ARE MADE. THE CONTRACTOR SHALL FURNISH THE ENGINEER A CERTIFICATE OF APPROVAL FROM THE LOCAL INSURANCE AUTHORITY HAVING JURISDICTION.
- I. WARRANTY: CONTRACTOR SHALL FURNISH WRITTEN WARRANTY, COUNTERSIGNED, AND GUARANTEED BY THE GENERAL CONTRACTOR, STATING THAT THE WORK EXECUTED UNDER THIS DIVISION OF THE SPECIFICATIONS SHALL BE FREE FROM DEFECTS OF MATERIALS AND WORKMANSHIP FOR A PERIOD OF 12 MONTHS FROM DATE OF FINAL ACCEPTANCE. DEFECTS DEVELOPING DURING THAT PERIOD SHALL BE CORRECTED WITHOUT COST TO THE OWNER.
- J. IT IS THE RESPONSIBILITY OF THE OWNER TO MAINTAIN THE INTEGRITY OF THE SYSTEMS. CONTRACTOR SHALL PROVIDE OWNER WITH COMPLETE OPERATION AND MAINTENANCE INFORMATION FROM EQUIPMENT MANUFACTURERS.

- K. PDF SCHEDULES OF MATERIALS AND EQUIPMENT PROPOSED FOR INSTALLATION SHALL BE SUBMITTED TO THE ENGINEER WITHIN 30 DAYS AFTER AWARD OF THE CONTRACT. THE SCHEDULES SHALL INCLUDE CATALOG CUTS, DIAGRAMS AND SUCH OTHER DESCRIPTIVE DATA AND/OR SAMPLES AS MAY BE REQUIRED BY THE ENGINEER. LIGHTING FIXTURE SUBMITTALS SHALL INCLUDE PHOTOMETRIC REPORTS BY INDEPENDENT TESTING LABORATORIES FOR EACH FIXTURE INDICATED BASED ON IES PUBLISHED PROCEDURES.
- L. SUBMITTALS THAT DO NOT BEAR THE GENERAL CONTRACTOR'S STAMP OF APPROVAL THEREON WILL BE REJECTED WITHOUT REVIEW.

2. GENERAL MATERIAL REQUIREMENTS:

- A. EQUIPMENT AND PRODUCTS TO BE USED SHALL BE REVIEWED AND APPROVED BY OWNER PRIOR TO PLACING ORDER OR PURCHASE.
- B. ALL MATERIALS AND EQUIPMENT SHALL BE NEW AND SHALL BEAR THE LABEL OF A NATIONALLY RECOGNIZED TESTING AGENCY AND SHALL BE INSTALLED IN THE MANNER FOR WHICH IT IS DESIGNED AND APPROVED.
- C. ALL MATERIAL, INCLUDING PULL BOXES, CONDUIT BODIES, FITTINGS AND MOUNTING HARDWARE INSTALLED OUTSIDE SHALL BE APPROVED WEATHERTIGHT CORROSION RESISTANT (STAINLESS STEEL OR NON-METALLIC), UNLESS NOTED OTHERWISE.
- D. CONTRACTOR SHALL INSPECT MATERIALS DELIVERED TO SITE FOR DAMAGE. UNLOAD AND STORE WITH MINIMUM HANDLING. STORE MATERIALS ON SITE IN ENCLOSURES OR UNDER PROTECTIVE COVERING. STORE PLASTIC PIPING UNDER COVER OUT OF DIRECT SUNLIGHT. DO NOT STORE MATERIALS DIRECTLY ON THE GROUND. KEEP INSIDE OF CONDUITS, FITTINGS AND EQUIPMENT FREE OF DIRT AND DEBRIS. HANDLE CONDUIT, FITTINGS, AND OTHER ACCESSORIES IN SUCH MANNER AS TO ENSURE DELIVERY TO THE INSTALLATION LOCATION IN A SOUND UNDAMAGED CONDITION.
- E. STARTERS, CONTROLLERS, THERMOSTATS, FAN SWITCHES, INDICATING LIGHTS, ETC.; AND CONTROL WIRING AND WIRING FOR REMOTE STATIONS REGARDLESS OF VOLTAGE SHALL BE PROVIDED UNDER THE DIVISION PROVIDING THE RESPECTIVE MOTOR AND/OR EQUIPMENT UNLESS OTHERWISE INDICATED.
- F. SUPPORTS AND HARDWARE SHALL BE TYPE 316 STAINLESS STEEL. SUBMIT SHOP DRAWINGS OR CATALOG DATA FOR REVIEW AND APPROVAL. A DIELECTRIC ISOLATION SHEET SHALL BE PLACED WHERE DISSIMILAR METALS CONTACT ON THE SUPPORT.
- G. PANELBOARDS, ENCLOSED CIRCUIT BREAKERS AND SAFETY SWITCHES, WHEN APPLICABLE, SHALL BE MANUFACTURED BY THE SAME MANUFACTURER. WIRING DEVICES SHALL BE MANUFACTURED BY ONE MANUFACTURER.
- H. SUBSTITUTION OF MATERIAL AND EQUIPMENT: THE NAME OF A CERTAIN BRAND, MAKE, MANUFACTURER OR DEFINITE SPECIFICATION IS TO DENOTE THE QUALITY STANDARD OF ARTICLE DESIRED. SUBSTITUTION OF ANY OTHER BRAND, MAKE, OR MANUFACTURER, WHICH IN THE OPINION OF THE ENGINEER IS RECOGNIZED THE EQUAL OF THAT SPECIFIED MAY BE ACCEPTED.
- I. PROVIDE ENGRAVED PLASTIC NAMEPLATES ON ALL DISTRIBUTION EQUIPMENT AND PANELS, SECURED BY MEANS OF STAINLESS STEEL RIVETS. TAPES AND ADHESIVES ARE NOT ACCEPTABLE.
- J. UNLESS NOTED OTHERWISE, ALL PANEL BUSES, FEEDER CONDUCTORS AND BRANCH CIRCUIT WIRING SHALL BE COPPER. ALL WIRE SHALL BE UL LISTED, RATED FOR 600 VOLTS, NO. 12 MINIMUM SIZE.
- K. ALL CIRCUIT BREAKERS, FUSES AND ELECTRICAL EQUIPMENT SHALL HAVE AN INTERRUPTING RATING NOT LESS THAN THE MAXIMUM SHORT CIRCUIT CURRENT TO WHICH THEY MAY BE SUBJECTED.

**VERTICAL DATUM**

- A. PROJECT ELEVATION BASED ON MLLW.
- B. ESTIMATED TIDAL PLANES AT PILLAR POINT HARBOR, BASED ON NOAA STATION ID 9415020.

TIDAL DATUM	WATER ELEVATION (FT, MLLW)
DESIGN HIGH WATER	9.10
HIGHEST OBSERVED WATER LEVEL	6.63
MEAN HIGHER HIGH WATER (MHHW)	5.60
MEAN HIGH WATER (MHW)	4.95
MEAN TIDE LEVEL (MTL)	3.03
MEAN SEA LEVEL (MSL)	2.99
MEAN LOW WATER (MLW)	1.14
MEAN LOWER LOW WATER (MLLW)	0.00
NAVD88	-0.04

**HORIZONTAL DATUM**

- A. PROJECT COORDINATES ARE BASED ON THE CALIFORNIA STATE PLANE COORDINATE SYSTEM NAD 1983, ZONE 3.

**ABBREVIATIONS**

&	AND
Ø	DIAMETER
#	NUMBER
%	PERCENT
2P	TWO POLE, OR AS INDICATED
A	AMPERES
APPROX	APPROXIMATE
ASTM	AMERICAN SOCIETY FOR TESTING AND MATERIALS
AWPA	AMERICAN WOOD PROTECTION ASSOCIATION
BLVD	BOULEVARD
C	CONDUIT
CA	CALIFORNIA
CB	CIRCUIT BREAKER
CKT	CIRCUIT
CL	CENTER LINE
CO	CONDUIT ONLY
CONC	CONCRETE
DIA	DIAMETER
DISC	DISCONNECT
E	EAST
EXIST (E)	EXISTING
EL	ELEVATION
ELEC	ELECTRICAL (POWER)
ELL	ELBOW
EP	ELECTRICAL PANEL
EPS	EXPANDED POLYSTYRENE (FOAM)
F'c	28-DAY CONCRETE COMPRESSIVE STRENGTH
FM	FIRE MARSHAL
FW	FIRE WATER
GND	GROUND
H	HORIZONTAL
HDPE	HIGH-DENSITY POLYETHYLENE
KIP	1000 POUNDS
KWH	KILOWATT HOUR
KVA	KILOVOLT AMPERE
LCL	CONTINUOUS LOAD
MAX	MAXIMUM
MB	MAIN BREAKER
MHW	MEAN HIGH WATER
MHHW	MEAN HIGHER HIGH WATER
MIN	MINIMUM
MLW	MEAN LOW WATER
MLLW	MEAN LOWER LOW WATER
MSL	MEAN SEA LEVEL
MTL	MEAN TIDE LEVEL
N	NORTH
NAD	NORTH AMERICAN DATUM
NAVD88	NORTH AMERICAN VERTICAL DATUM
NEC	NATIONAL ELECTRICAL CODE
NEUT	NEUTRAL
NFPA	NATIONAL FIRE PROTECTION ASSOCIATION
NIC	NOT IN CONTRACT (BY OTHERS)
NTS	NOT TO SCALE
OC	ON CENTER
PB	PULL BOX
PG&E	PACIFIC GAS & ELECTRIC
PH	PHASE
PVC	POLYVINYL CHLORIDE

POC	POINT OF CONNECTION
PSI	POUNDS PER SQUARE INCH
RGS	RIGID GALVANIZED STEEL
SC	SHORT CIRCUIT
SCH SCHED	SCHEDULE
SIM	SIMILAR
SMCHD	SAN MATEO COUNTY HARBOR DISTRICT
SS	STAINLESS STEEL OR SANITARY SEWER
SYMM	SYMMETRICAL
TEL, TELE	TELEPHONE
TYP	TYPICAL
UHMW	ULTRA HIGH MOLECULAR WEIGHT
UON	UNLESS OTHERWISE NOTED
V	VOLT
VD	VOLTAGE DROP
VIF	VERIFY IN FIELD
W	WATER, WATT, WIRE
W/	WITH
XFMR	TRANSFORMER

**LEGEND**

	EXISTING FEATURE
	PROPOSED FEATURE
	EXISTING CONTOUR
	WATER LINE
	FIRE WATER LINE
	DEMOLISH AND REMOVE
	WATER SURFACE
	CONTROL POINT
	GROUND CONNECTION
	PVC CONDUIT CONCEALED WITHIN DOCK OR BELOW GRADE
	CIRCUIT BREAKER, SIZE AND TYPE AS INDICATED
	TRANSFORMER, SIZE AND TYPE AS INDICATED
	DASHED SYMBOLS INDICATE EXISTING
	DISCONNECT SWITCH, SIZE AS INDICATED IN DRAWINGS

**CROSS-REFERENCE LEGEND**

	VIEW		VIEW
	<b>SAMPLE VIEW TITLE</b> SCALE: 1"=50'		<b>SHEET VIEW REFERENCED FROM</b>
	<b>VIEW TITLE</b>		<b>DETAIL CALLOUT</b>
	VIEW		VIEW
	<b>SHEET VIEW REFERENCED FROM</b>		<b>SHEET VIEW REFERENCED SHOWN</b>
	<b>SECTION CALLOUT</b>		<b>KEYED NOTE</b>

NOTE: LETTER INDICATES SECTION; NUMBER INDICATES PLAN, ELEVATION, OR DETAIL. WHERE THERE IS NO REFERENCE SHEET INDICATED, IT MEANS THE DETAIL OR SECTION IS TAKEN AND SHOWN ON THE SAME SHEET.



**SAN MATEO COUNTY HARBOR DISTRICT**

504 Avenue Alhambra, 2nd Floor  
El Granada, CA 94018  
(650) 741-9163

REVISION	DESCRIPTION	BY	DATE



2185 N. CALIFORNIA BLVD.  
SUITE 500  
WALNUT CREEK, CA 94596

DSGN	DJS	DR	RJC	CHK	KK
JOB NO.	9673-09	SUBMITTED BY	BRAD PORTER	TITLE	PROJECT MANAGER

SAN MATEO COUNTY HARBOR DISTRICT

JOHNSON PIER ELECTRIC UPGRADES

DATE 4-9-2024

SHEET 2 OF 8

**GENERAL NOTES & ABBREVIATIONS**

**GE02**



**EXISTING SITE PLAN**  
SCALE: 1" = 80'

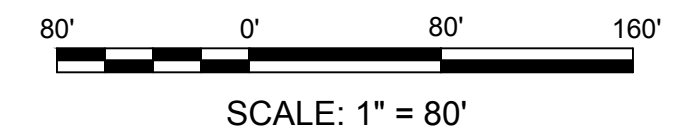

File: C:\Users\jchun\OneDrive\Documents\Projects\9673-09\9673-09\_ExistingSitePlan.dwg, Plot: 4/10/2024 4:42 PM by: CHUN, JUSTIN, Saved: 10/27/2022 10:28 AM by: JCHUN



**SAN MATEO COUNTY HARBOR DISTRICT**  
 504 Avenue Alhambra, 2nd Floor  
 El Granada, CA 94018  
 (650) 741-9163

REVISION	DESCRIPTION	BY	DATE



  
**moffatt & nichol**  
 2185 N. CALIFORNIA BLVD.  
 SUITE 500  
 WALNUT CREEK, CA 94596

DSGN	DJS	DR	RJC	CHK	KK
JOB NO.	9673-09	SUBMITTED BY	BRAD PORTER	TITLE	PROJECT MANAGER

**SAN MATEO COUNTY HARBOR DISTRICT**  
 JOHNSON PIER ELECTRIC UPGRADES

DATE 4-9-2024  
 SHEET 3 OF 8

**EXISTING SITE PLAN**

**GE03**

**ELECTRICAL NOTES**

**1. GENERAL INSTALLATION REQUIREMENTS:**

- A. INSTALL MATERIALS AND EQUIPMENT IN FIRST CLASS AND WORKMANLIKE MANNER AND RUN CONCEALED, EXCEPT AS INDICATED.
- B. POWER WIRING AND POWER CONNECTIONS TO EQUIPMENT SHALL BE PROVIDED UNDER "ELECTRICAL" UNLESS OTHERWISE INDICATED ON THE ELECTRICAL DRAWINGS. WHEN SUBSTITUTED MOTORS AND/OR EQUIPMENT REQUIRES ELECTRICAL MODIFICATIONS, THE COST OF THE ELECTRICAL MODIFICATIONS AND COORDINATION SHALL BE INCLUDED UNDER THE DIVISION PROVIDING THE MOTOR AND/OR EQUIPMENT.
- C. THE ELECTRICAL CONTRACTOR SHALL NOT BORE, NOTCH OR IN ANY WAY CUT INTO ANY STRUCTURAL MEMBER, WITHOUT APPROVAL FROM THE ENGINEER AND HARBOR DISTRICT. THE ELECTRICAL CONTRACTOR SHALL PROVIDE SUPPORT FOR ALL ELECTRICAL EQUIPMENT TO COMPLY WITH THE REQUIREMENTS OF THE LATEST ADOPTED BUILDING CODE AND ALL LOCAL ORDINANCES.
- D. SCHEDULING, TRENCHING, LINE SHUTDOWN, DRAINAGE, TIE-IN, CONDUIT BEDDING, SUPPORTS, INSTALLATION OF NEW LINE, WALL PENETRATIONS, AND EQUIPMENT PLACEMENTS, TESTING, WARNING TAPE, BACKFILL, SURFACING, LANDSCAPING, ACTIVATION OF SERVICE, ETC., SHALL COMPLY WITH THE LOCAL BUILDING CODE STANDARDS AND REGULATIONS AND SHALL BE COORDINATED WITH THE LOCAL CODE OFFICIAL AND THE FIRE DEPARTMENTS. PRIOR APPROVAL OF AND NOTICE TO PROCEED WITH CONCEALING ELECTRICAL WIRING AND FINAL CONNECTIONS ARE REQUIRED BY THE LOCAL AUTHORITY HAVING JURISDICTION.
- E. THE OWNER'S AUTHORIZED REPRESENTATIVE SHALL WITNESS TESTING.
- F. CONTRACTOR SHALL VERIFY ALL EXISTING UTILITY LOCATIONS IN THE FIELD BEFORE STARTING WORK. THE REGIONAL NOTIFICATION CENTER (AND/OR PROPERTY OWNERS) SHALL BE NOTIFIED 48 HOURS PRIOR TO THE START OF SHUTDOWN, DIGGING OR EXCAVATION WORK. THE CONTRACTOR SHALL FIELD VERIFY THE POINTS OF CONNECTIONS AND PHASED CONSTRUCTION TIE-INS. LOCATIONS OF PIPING AND APPURTENANT FITTINGS SHOWN ON THE DRAWINGS ARE APPROXIMATE. IT IS INTENDED THAT SUCH ITEMS BE LOCATED BASED ON EXACT LOCATIONS DETERMINED IN THE FIELD AND THE SUPPLIED MATERIALS.
- G. CONTRACTOR SHALL PROVIDE ALL NECESSARY PROTECTIVE MEASURES TO SAFEGUARD EXISTING UTILITIES TO REMAIN FROM DAMAGE DURING CONSTRUCTION OF THIS PROJECT. SHOULD SPECIAL EQUIPMENT BE REQUIRED TO WORK OVER AND AROUND THE UTILITIES, CONTRACTOR SHALL BE REQUIRED TO FURNISH SUCH EQUIPMENT. THE COST OF PROTECTING UTILITIES FROM DAMAGE AND FOR FURNISHING SPECIAL EQUIPMENT SHALL BE INCLUDED IN THE PRICE BID FOR OTHER ITEMS OF CONSTRUCTION.
- H. DIELECTRIC COUPLINGS/FLANGES SHALL BE USED AT DISSIMILAR METAL PIPING CONNECTIONS.
- I. SUPPORTS AND HANGERS SHALL BE STAINLESS STEEL AND SHALL BE FROM MANUFACTURED SHAPES. FIELD BENDING IS NOT PERMITTED. PLATE MATERIAL MAY BE WELDED IN THE FIELD TO FORM SHAPES.
- J. THE ELECTRICAL CONTRACTOR SHALL INSTALL ALL CONDUITS AND WIRES WITH A MINIMUM NUMBER OF BENDS AND IN SUCH A MANNER AS TO CONFORM TO THE STRUCTURE. AVOID OBSTRUCTIONS, AND MEET ALL STRUCTURAL CODE REQUIREMENTS. THESE DRAWINGS ARE PRIMARILY DIAGRAMMATIC, AND DO NOT SHOW ALL SUCH REQUIRED BENDS, OFFSETS, FITTING, BOXES, ETC. THERE SHALL NOT BE MORE THAN THE EQUIVALENT OF FOUR QUARTER BENDS (360 DEGREES TOTAL) BETWEEN PULL POINTS.
- K. THE ENTIRE ELECTRICAL INSTALLATION SHALL BE GROUNDED AS REQUIRED BY NATIONAL ELECTRICAL CODE (NEC). POWER CONDUITS SHALL HAVE AN INSULATED COPPER, CODE SIZED GROUND WIRE INSTALLED.
- L. SUPPORTS AND HANGERS SHALL BE 316L STAINLESS STEEL (UNLESS OTHERWISE NOTED) AND SHALL BE MANUFACTURED SHAPES. FIELD BENDING IS NOT PERMITTED. PLATE MATERIAL MAY BE WELDED IN THE FIELD TO FORM SHAPES.
- M. ALL EQUIPMENT, INCLUDING WIREWAYS, FITTINGS, CONDUIT BODIES, AND MOUNTING HARDWARE INSTALLED OUTSIDE AND ON DOCKS SHALL BE APPROVED WEATHERTIGHT CORROSION RESISTANT (STAINLESS STEEL 316L OR NON-METALLIC), UNLESS OTHERWISE NOTED.
- N. FURNISH AND INSTALL ALL CONDUIT, WIRES, WIREWAYS, BOXES, SWITCHES, TRANSFORMERS, AND RELATED ELECTRICAL GEAR FOR A COMPLETE AND OPERATIONAL ELECTRICAL SYSTEM.

**2. CONDUIT REQUIREMENTS:**

- A. BURIED CONDUIT LINES SHALL HAVE PLASTIC WARNING TAPE WITH METALLIC CORE OR METAL FACED PLACED IN TRENCH ABOVE PIPING. THE TAPE SHALL BE PLACED 9 INCHES TO 12 INCHES BELOW FINISHED GRADE.
- B. ALL CONDUIT SHALL FOLLOW THE GENERAL ARRANGEMENT SHOWN. CONDUIT SHALL BE RUN ESSENTIALLY AS INDICATED, CARE BEING TAKEN TO AVOID INTERFERENCE WITH OTHER PIPING, CONDUIT OR EQUIPMENT. BEFORE JOINTING AND INSTALLATION OF CONDUIT, THOROUGHLY CLEAN INTERIORS OF CONDUIT, AND COMPONENTS. MAINTAIN CLEANLINESS BY CLOSURE OF CONDUIT OPENINGS WITH CAPS OR PLUGS.
- C. THE CONTRACTOR SHALL ENSURE SUFFICIENT CONDUIT FLEXIBILITY AND ANCHORAGE IS PROVIDED FOR ALL LINES FOR THERMAL EXPANSION AND CONTRACTION, PRESSURE AND WHARF FLEXING. THE STRUCTURE AND COMPONENTS SHALL ACCOMMODATE THE CONDUIT LAYOUT REQUIREMENTS SUCH THAT THE CONDUIT SHALL NOT BECOME OVERSTRESSED. THE CONDUIT SHALL BE PROPERLY SUPPORTED AND ANCHORED.
- D. CONDUIT AND FITTINGS SHALL CONFORM TO THE FOLLOWING:
  - RIGID STEEL - ANSI C80 (HOT DIPPED GALVANIZED).
  - PLASTIC CONDUIT (PVC) - NEMA TC-2 AND TC-3.
  - LIQUID-TIGHT FLEXIBLE METAL CONDUIT - UL-360.
- E. CONDUIT SHALL BE RUN CONCEALED, EXCEPT CONDUIT MAY BE EXPOSED AS APPROVED BY THE ENGINEER. WHERE FLEXIBILITY IS REQUIRED, PROVIDE LIQUID TIGHT FLEXIBLE METAL CONDUIT EXCEPT AS INDICATED OTHERWISE. CONDUITS RUN EXPOSED SHALL BE RIGID GALVANIZED STEEL.
- F. CONDUIT RUN ON LAND SHALL BE BURIED A MINIMUM OF 36 INCHES BELOW FINISHED

- G. GRADE. CONDUITS RUN BELOW SLAB ON GRADE SHALL BE BURIED A MINIMUM OF 12 INCHES BELOW SLAB, AND SHALL BE RIGID HOT DIPPED GALVANIZED STEEL CONDUIT PAINTED WITH TWO COATS OF BITUMASTIC PAINT, OR RIGID NON-METALLIC POLYVINYL CHLORIDE CONDUIT, MINIMUM SCHEDULE 40, AT THE OPTION OF THE CONTRACTOR, UNLESS A SPECIFIC TYPE OF CONDUIT IS SPECIFIED OR INDICATED ON THE DRAWINGS.
- H. MINIMUM SIZE CONDUIT SHALL BE THREE QUARTER INCH WITH LARGER SIZES AS REQUIRED BY THE NATIONAL ELECTRICAL CODE FOR NUMBER OF WIRES CONTAINED THEREIN.
- I. CONDUITS FOR COMMUNICATIONS CIRCUITS SHALL BE THREE QUARTER INCH DIAMETER MINIMUM FOR A SINGLE CABLE, ONE INCH DIAMETER MINIMUM FOR MORE THAN ONE CABLE AND LARGER CONDUIT DIAMETERS AS DIRECTED BY TIA AND BICSI RECOMMENDATIONS.
- J. RIGID CONDUIT FITTINGS SHALL BE THREADED.
- K. FLEXIBLE CONDUIT SHALL BE GALVANIZED, SINGLE STRIP TYPE. IN AREAS SUBJECT TO MOISTURE, OR WHERE CALLED FOR ON THE DRAWINGS, FITTINGS SHALL BE STANDARD UL APPROVED WITH GROUND CONNECTOR. WATER TIGHT CONNECTORS SHALL BE USED WITH PLASTIC COVERED CONDUIT. FLEXIBLE CONDUIT, MINIMUM 18 INCHES IN LENGTH, SHALL BE USED FOR CONNECTIONS TO MOTORS, DRY TYPE TRANSFORMERS AND OTHER EQUIPMENT SUBJECT TO VIBRATION.
- L. EXPOSED CONDUITS SHALL BE RUN PARALLEL AND PERPENDICULAR TO STRUCTURES AND SHALL BE SUPPORTED AS SPECIFIED AND IN ACCORDANCE WITH NEC.
- M. CONDUIT SUPPORTS SHALL BE APPROVED WALL BRACKETS, TRAPEZE, STRAP HANGER OR PIPE STRAPS SECURED TO HOLLOW MASONRY WITH TOGGLE BOLTS; TO BRICK AND CONCRETE WITH EXPANSION BOLTS; TO METAL SURFACES WITH MACHINE SCREWS; AND TO WOOD WITH WOOD SCREWS. ANY FORM OF TIE WIRE IS UNACCEPTABLE.
- N. CONDUIT TERMINATIONS AND CONDUIT STUBS SHALL HAVE INSULATING BUSHINGS.
- O. PROVIDE EXPANSION FITTINGS WHERE CONDUITS CROSS EXPANSION JOINTS. PROVIDE SLIP JOINTS AS NECESSARY FOR THERMAL EXPANSION AND CONTRACTION.
- P. CONDUITS AND CABLES PASSING THROUGH BULKHEADS, CONCRETE WALLS, FLOORS, OR FOOTINGS AND SLAB ON GRADE SHALL BE MADE WATER TIGHT. PROVIDE PIPE SLEEVES WITH ONE-HALF INCH MINIMUM CLEARANCE AROUND THE CONDUIT AND CAULK WITH SEALANT.
- Q. PROVIDE 12" MINIMUM SEPARATION BETWEEN ELECTRICAL AND OTHER UTILITIES.
- R. PROVIDE STAINLESS STEEL CABLE/CONDUIT TAGS WITH STAINLESS STEEL STRAPS. EMOSS TAG WITH PANEL/GEAR CIRCUIT INFORMATION FOR EACH CONDUIT AND WIRE. THIS APPLIES TO ALL CONDUIT/WIRE TERMINATIONS, EXPOSED CONDUIT AT TERMINATIONS AND EVERY 100' OF EXPOSED CONDUITS.

**3. WIRING REQUIREMENTS:**

- A. THE ENTIRE WIRING SYSTEM SHALL BE TESTED FOR SHORT CIRCUITS, GROUNDS AND INSULATION RESISTANCE BETWEEN CONDUCTORS AND TO GROUND PRIOR TO COMPLETION OF PROJECT.
- B. WIRE AND CABLE SHALL BE INSTALLED IN CONDUIT EXCEPT AS SPECIFICALLY INDICATED OTHERWISE.
- C. WIRE AND CABLE SHALL BE COPPER, 600 VOLT INSULATION, MINIMUM SIZE NO. 12, TYPE "THWN" OR "XHHW" AS APPLICABLE, UNLESS OTHERWISE INDICATED ON DRAWINGS.
- D. WIRES NO. 10 AND 12 AWG SHALL BE CONNECTED WITH COIL SPRING INSERT "WIRE-NUT" OR "WING-NUT" CONNECTORS MANUFACTURED BY IDEAL INDUSTRIES OR APPROVED EQUAL. CONNECTORS SHALL BE RATED 600 VOLTS.
- E. PROVIDE CABLE LUGS ON ALL CABLES REQUIRED TO PROPERLY TERMINATE ON THE EQUIPMENT AS NECESSARY.
- F. WIRE SHALL BE COLOR CODED AS FOLLOWS:

480Y/277V SYSTEM	208Y/120V SYSTEM	120/240V 1 PH SYSTEM
PH A - BRN	PH A - BLK	PH A - BLK
PH B - ORN	PH B - RED	PH B - RED
PH C - YEL	PH C - BLU	PH C - BLU
NEUT - GRY	NEUT - WHT	NEUT - WHT W/GRY STRIPE
GND - GRN W/YEL STRIPE	GND - GRN	GND - GRN W/WHT STRIPE

**4. DISCONNECT SWITCHES**

- A. SWITCHES SHALL BE NEMA TYPE "HD". FUSED SWITCHES SHALL BE NEMA TYPE "HD" UNLESS OTHERWISE INDICATED, WITH CLASS "R" FUSE CLIPS. MAIN DISCONNECT SWITCHES AND SWITCHES RATED 600 VOLTS SHALL BE TYPE "HD" AND HAVE FULL COVER INTERLOCKS AND QUICK-MAKE, QUICK-BREAK MECHANISM.
- B. FUSED SWITCHES SHALL BE PROVIDED COMPLETE WITH FUSES. ENCLOSURES SHALL BE NEMA 4X STAINLESS STEEL.
- C. SWITCHES SHALL BE SQUARE D OR APPROVED EQUAL.
- D. SWITCHES SHALL BE SECURELY MOUNTED TO WALL, STRUCTURE, OR EQUIPMENT. PROVIDE MISCELLANEOUS ACCESSORIES FOR MOUNTING SWITCHES, INCLUDING STEEL ANGLES WHERE REQUIRED.
- E. FUSES FOR PROTECTION OF MECHANICAL AND PLUMBING EQUIPMENT SHALL BE "FUSETRON" UL CLASS "RK5" SIZED PER MANUFACTURER'S RECOMMENDATION, UNLESS OTHERWISE INDICATED.

**5. DRY TYPE TRANSFORMERS**

- A. SHALL BE IN ACCORDANCE WITH NEMA STANDARDS. KVA RATINGS AND MOUNTING SHALL BE AS INDICATED. TRANSFORMER PRIMARY VOLTAGE AND SECONDARY VOLTAGE SHALL BE AS INDICATED. INSULATION SHALL BE EQUAL TO THE PRIMARY VOLTAGE AS A MINIMUM BUT NOT LESS THAN THE INDUSTRY STANDARD FOR THE VOLTAGES, RATED 150 DEGREES CENTIGRADE FOR LARGER SIZES. TRANSFORMERS, 30 KVA AND LARGER, SHALL HAVE FOUR TWO AND ONE-HALF PERCENT TAPS BELOW AND TWO, TWO AND ONE-HALF PERCENT ABOVE NORMAL PRIMARY VOLTAGE; AND 15 KVA TRANSFORMERS AND SMALLER SHALL HAVE TWO, TWO AND ONE-HALF PERCENT TAPS BELOW AND TWO, TWO AND ONE-HALF PERCENT TAPS ABOVE NORMAL PRIMARY VOLTAGE. TRANSFORMERS SHALL BE QUIET TYPE WITH NOISE LEVEL BELOW 45 DECIBELS. PROVIDE TRANSFORMERS WITH "KINETICS" MODEL "N", FIBERGLASS ISOLATORS OR EQUAL. TRANSFORMERS SHALL BE AS MANUFACTURED BY SQUARE D OR EQUAL. TRANSFORMERS SHALL BE ENCAPSULATED TYPE WITH STAINLESS STEEL NEMA 3R ENCLOSURE.

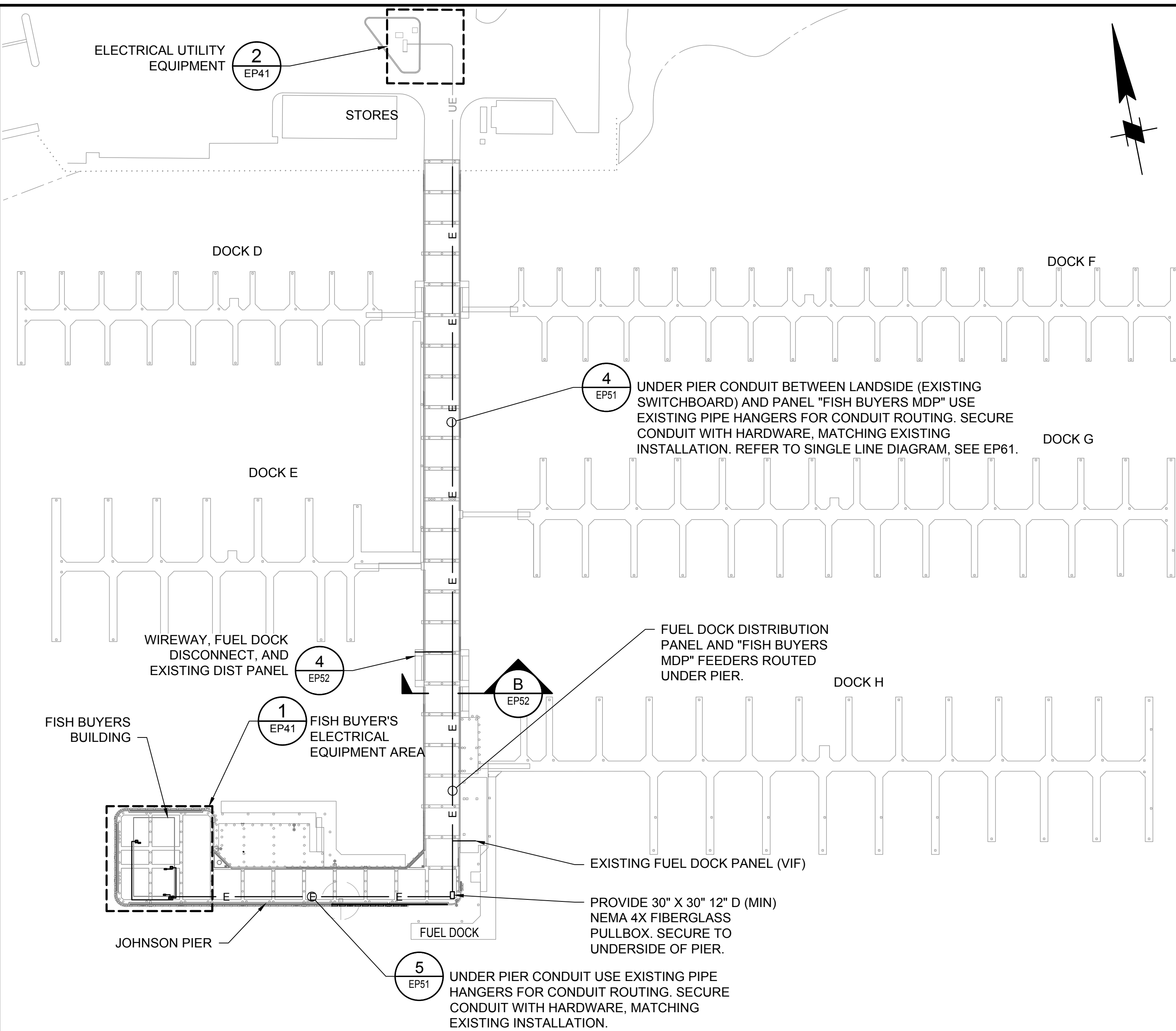

**1 GENERAL PLAN**  
SCALE: 1" = 60'

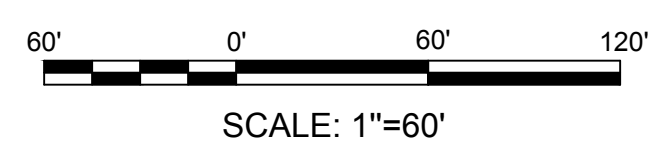

File: C:\M\2023\Johnson Pier Improvements\4\_CADD\_Activity\DWG\JohnsonPier\_Electrical\_EP01.dwg, Plotter: 4/10/2024 4:40 PM, by: JDNW

**SAN MATEO COUNTY HARBOR DISTRICT**

504 Avenue Alhambra, 2nd Floor  
El Granada, CA 94018  
(650) 741-9163

REVISION	DESCRIPTION	BY	DATE

REG. LICENSED PROFESSIONAL ENGINEER  
No. E19908  
EXP. 3/31/26  
ELECTRICAL  
STATE OF CALIFORNIA

**moffatt & nichol**

2185 N. CALIFORNIA BLVD.  
SUITE 500  
WALNUT CREEK, CA 94596

DSGN: DJS    DR: RJC    CHK: KK

JOB NO. 9673-09    SUBMITTED BY: BRAD PORTER    TITLE: PROJECT MANAGER

**SAN MATEO COUNTY HARBOR DISTRICT**

JOHNSON PIER ELECTRIC UPGRADES

**ELECTRICAL PLAN,  
LEGEND AND NOTES**

DATE: 4-9-2024

SHEET: 4 OF 8

**EP01**

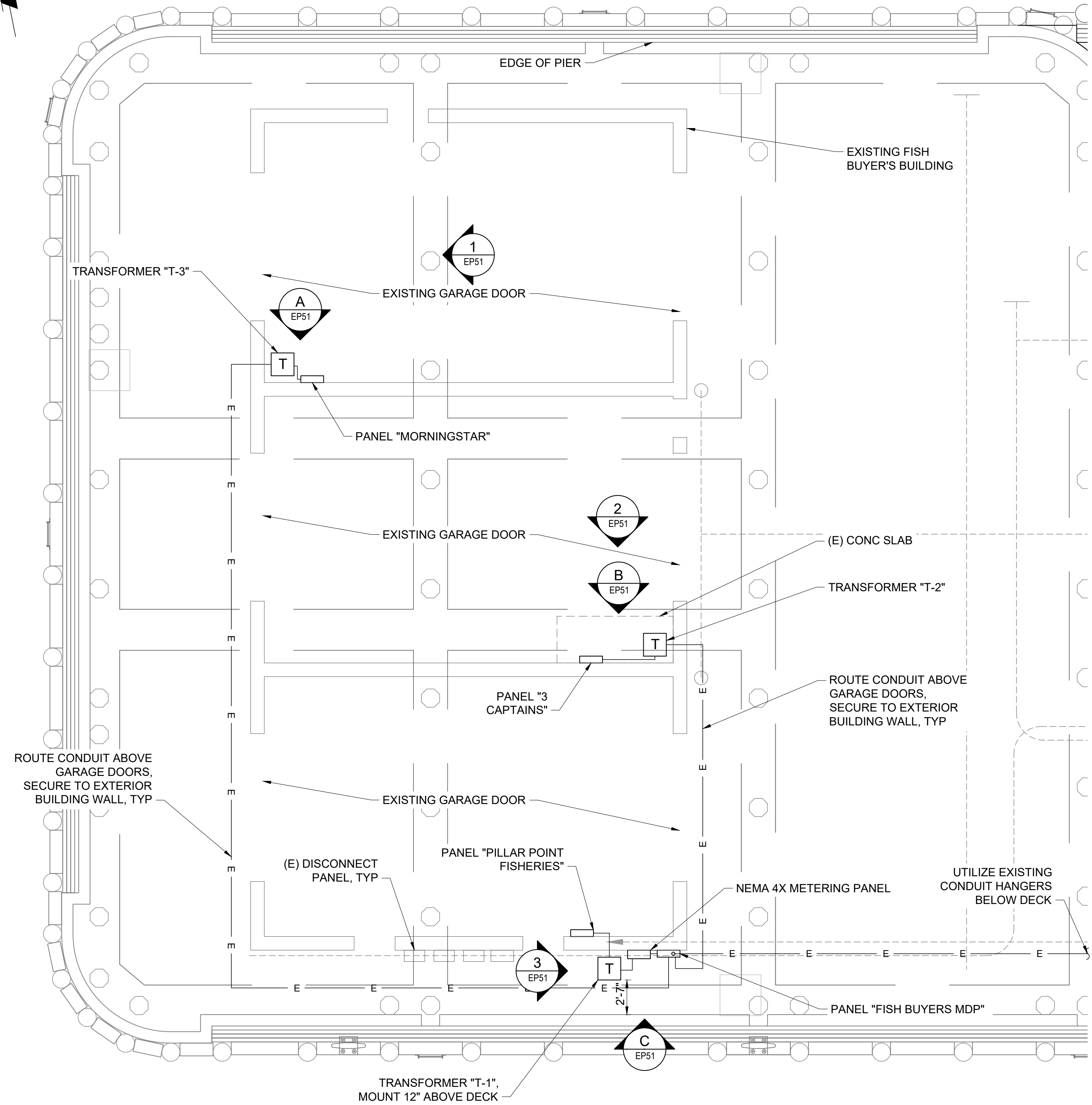
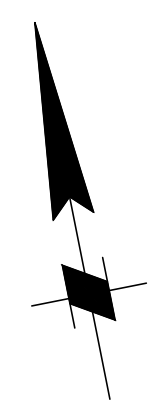

**1 FISH BUYER'S ELECTRICAL EQUIPMENT AREA**  
EP01 SCALE: 1" = 5'

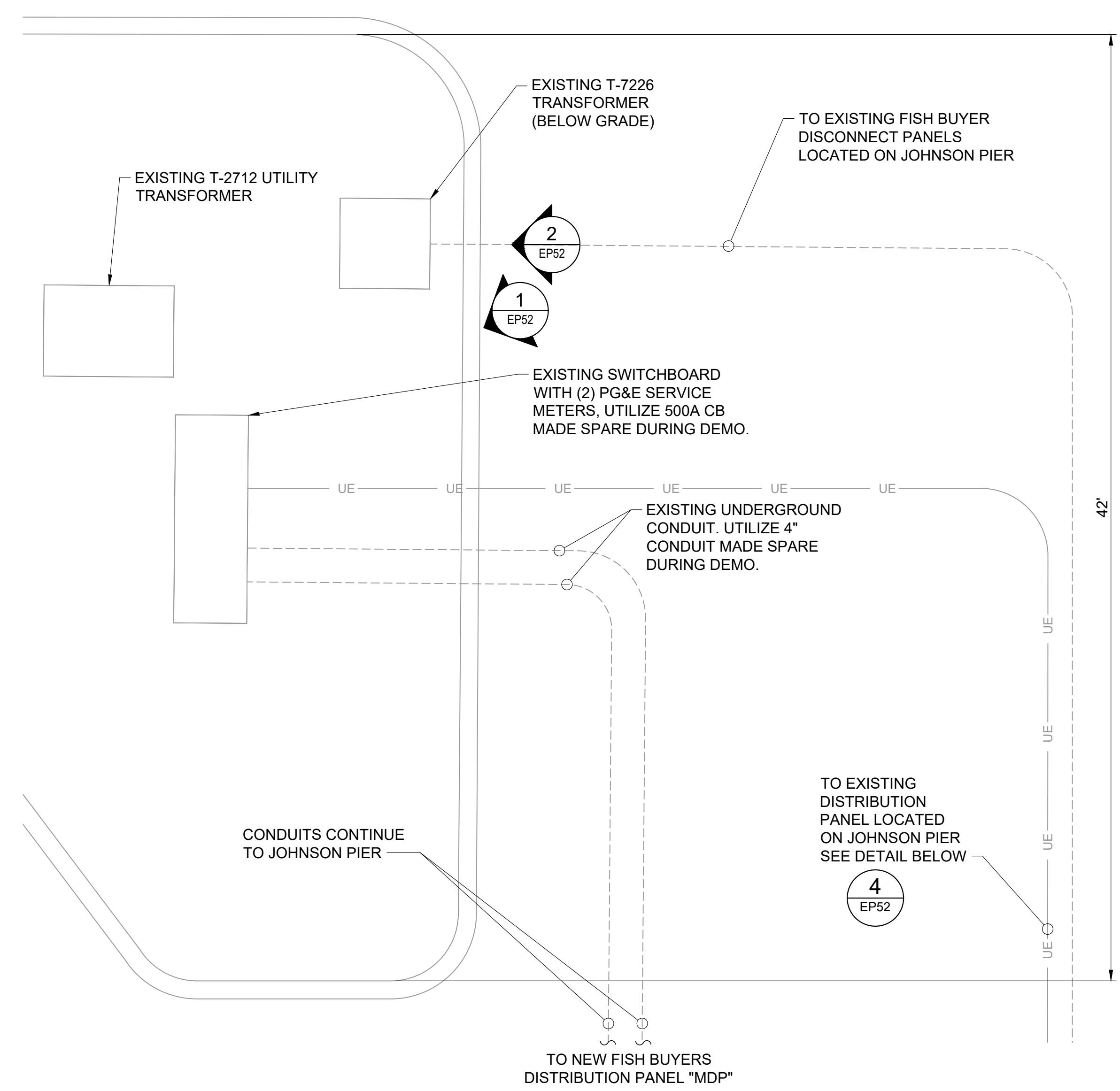

**2 ELECTRICAL UTILITY EQUIPMENT**  
EP01 SCALE: 1/4" = 1'-0"

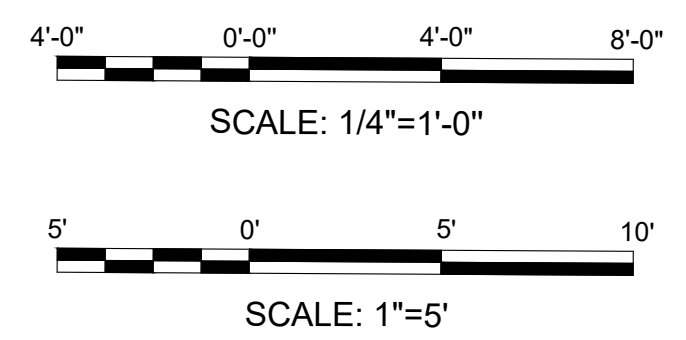

File: C:\Projects\2020\Johnson Pier Improvements\4\_CADD\_Active\DWG\_Boysen\EP01.dwg, Plotter: 4/11/2024 8:17 AM by: CHN, JGSTN, Saved: 4/11/2024 8:17 AM by: JCHW



**SAN MATEO COUNTY HARBOR DISTRICT**  
504 Avenue Alhambra, 2nd Floor  
El Granada, CA 94018  
(650) 741-9163

REVISION	DESCRIPTION	BY	DATE



**moffatt & nichol**  
2185 N. CALIFORNIA BLVD.  
SUITE 500  
WALNUT CREEK, CA 94596

DSGN: DJS	DR: JE	CHK: TS
JOB NO.: 9673-09	SUBMITTED BY: BRAD PORTER	TITLE: PROJECT MANAGER

SAN MATEO COUNTY HARBOR DISTRICT  
JOHNSON PIER ELECTRIC UPGRADES  
DATE: 4-9-2024  
SHEET 5 OF 8

**ENLARGED ELECTRICAL EQUIPMENT LAYOUT**  
**EP41**

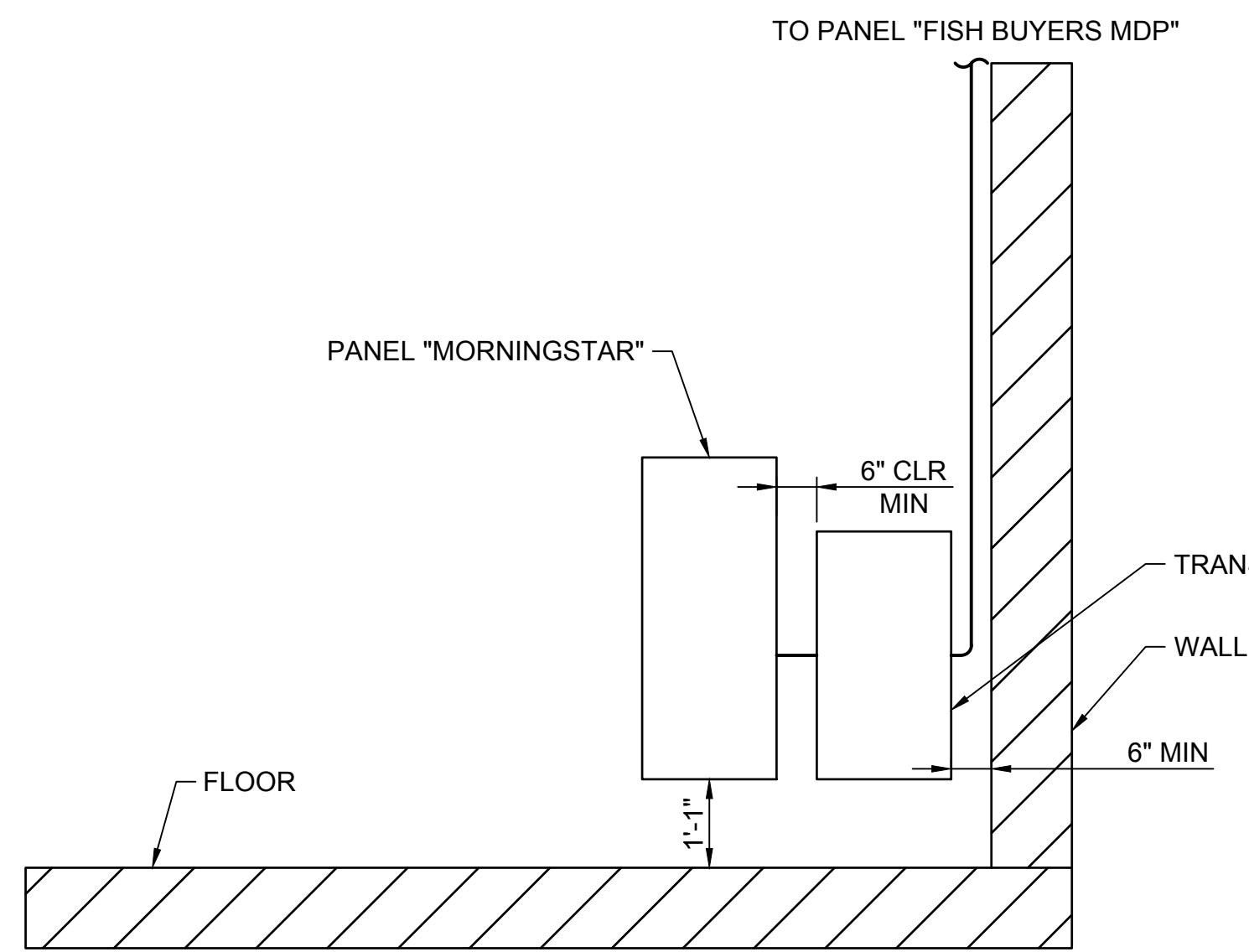

**A** ELEVATION - MORNINGSTAR  
EP41 SCALE: 1/2" = 1'-0"



**1** MORNINGSTAR EQUIPMENT LOCATION  
EP41 SCALE: NTS

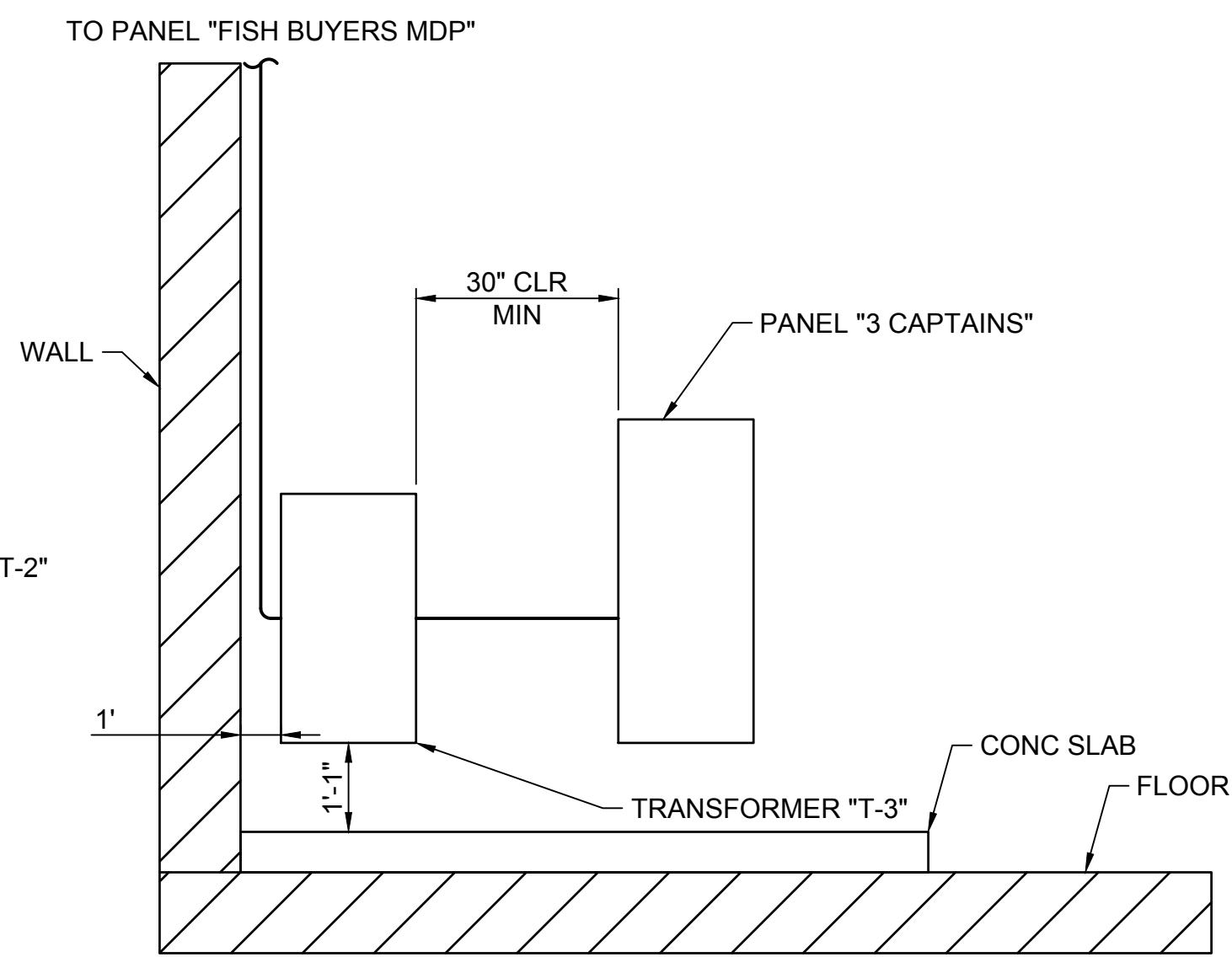

**B** ELEVATION - 3 CAPTAINS  
EP41 SCALE: 1/2" = 1'-0"

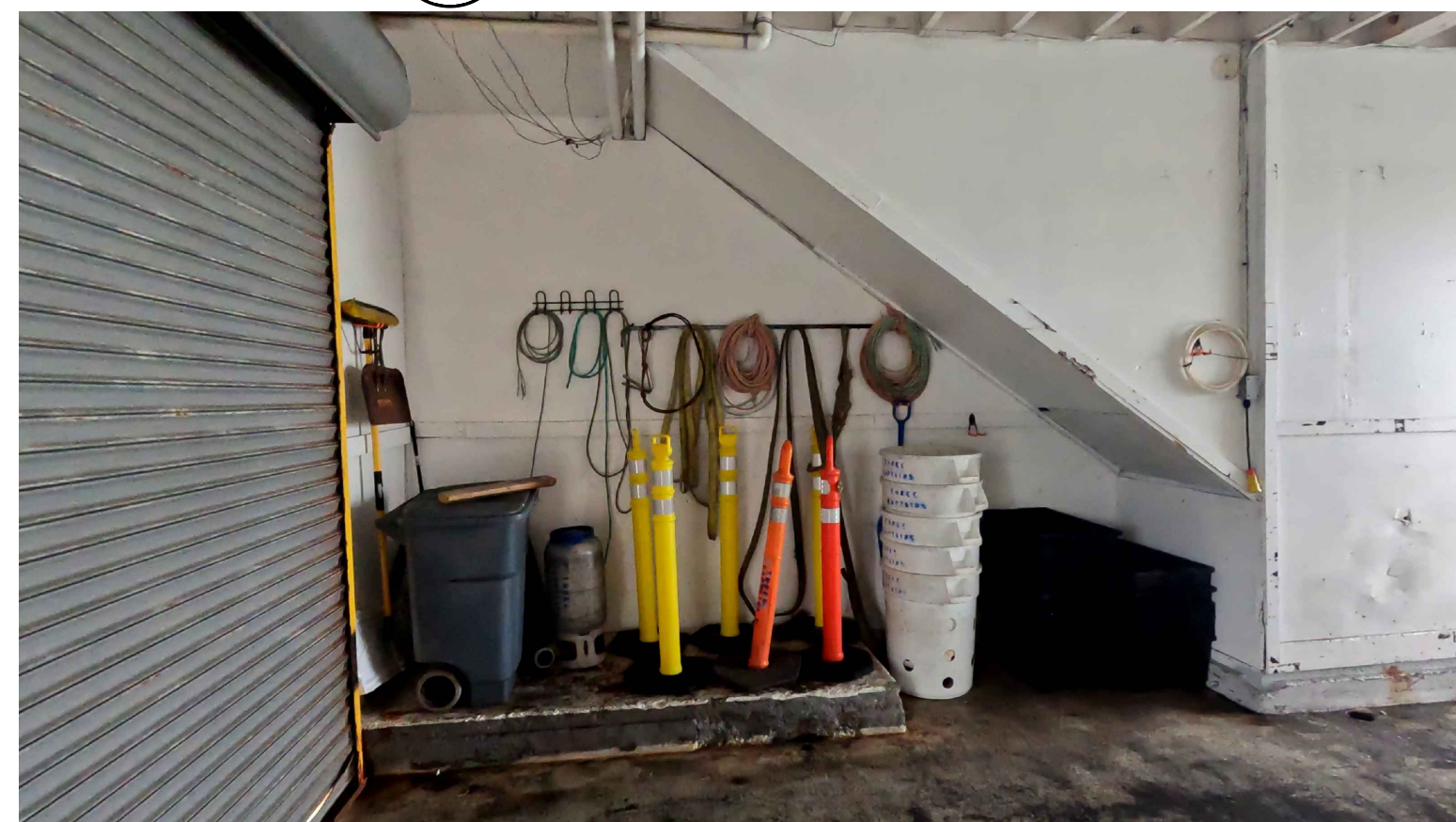

**2** 3 CAPTAINS EQUIPMENT LOCATION  
EP41 SCALE: NTS

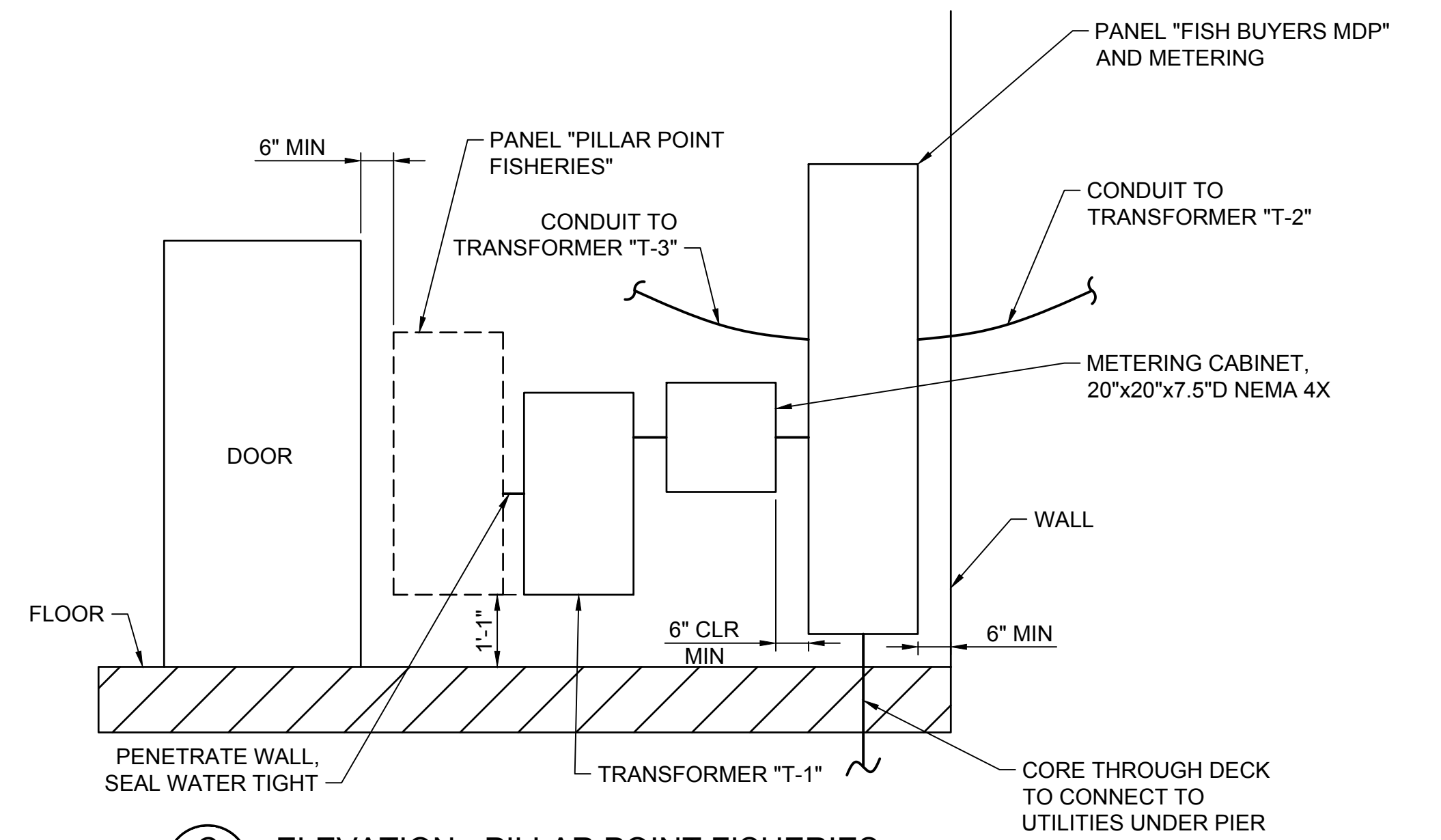

**C** ELEVATION - PILLAR POINT FISHERIES  
EP41 SCALE: 1/2" = 1'-0"

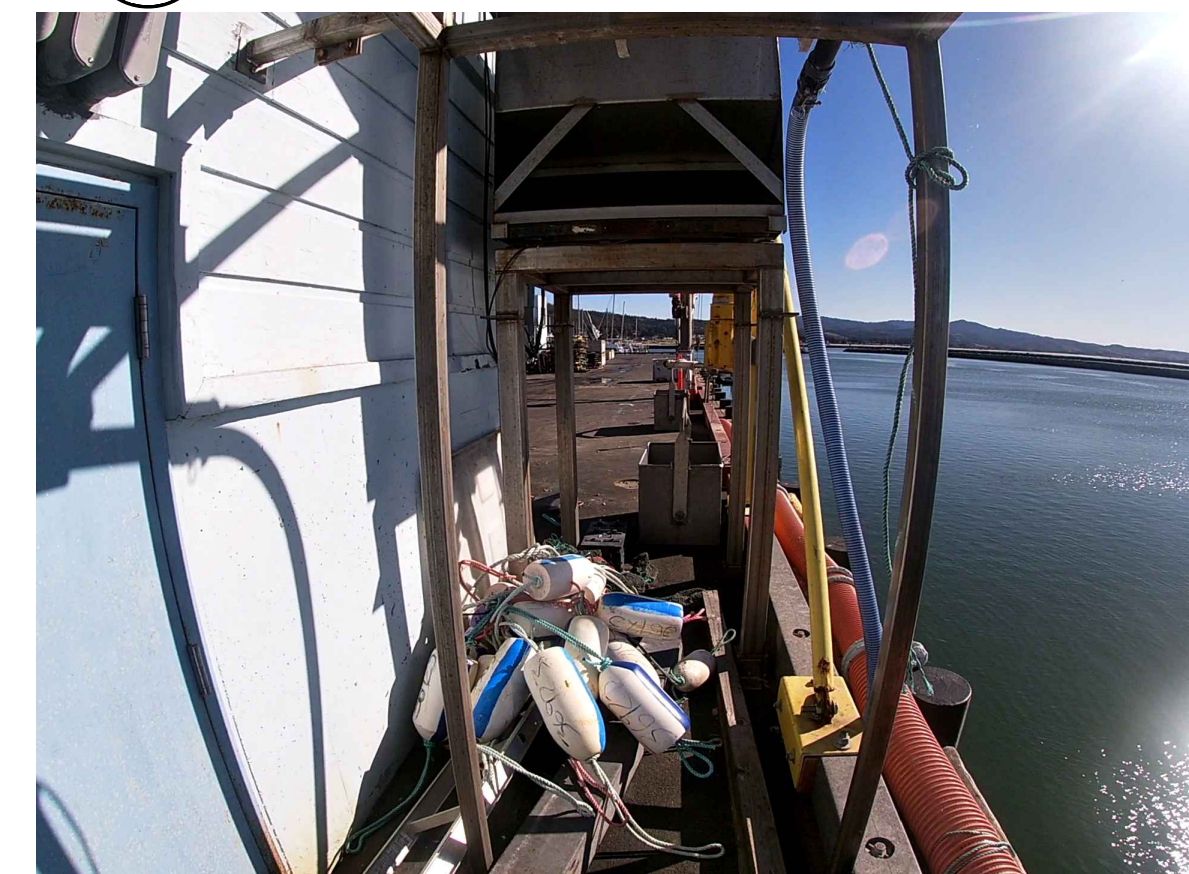

**3** PILLAR POINT FISHERIES EQUIPMENT LOCATION  
EP41 SCALE: NTS



**4** EXISTING EAST SIDE PIPE HANGERS  
EP01 SCALE: NTS



**5** EXISTING SOUTH SIDE PIPE HANGERS  
EP01 SCALE: NTS

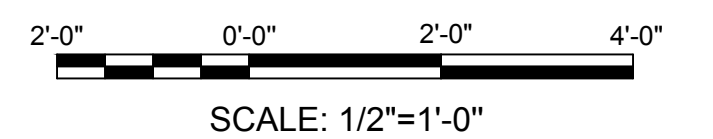

SAN MATEO COUNTY HARBOR DISTRICT  
504 Avenue Alhambra, 2nd Floor  
El Granada, CA 94018  
(650) 741-9163

REVISION	DESCRIPTION	BY	DATE



<b>moffatt &amp; nichol</b>		2185 N. CALIFORNIA BLVD. SUITE 500 WALNUT CREEK, CA 94596	
DSGN DJS	DR JE	CHK KK	TITLE PROJECT MANAGER
JOB NO. 9673-09		SUBMITTED BY BRAD PORTER	

SAN MATEO COUNTY HARBOR DISTRICT		DATE 4-9-2024
JOHNSON PIER ELECTRIC UPGRADES		SHEET 6 OF 8
ELECTRICAL DETAILS (1 OF 2)		EP51

File: C:\Users\bradp\OneDrive\Documents\San Mateo County Harbor District\EP51 - Johnson Pier Improvements\4\_CADD\_Arch\EP51\_Arch\Submittals\EP51\_Arch.dwg, Plotter: 4/10/2024 4:42 PM by: CHN, PLOT: 4/10/2024 4:40 PM by: CHN



LOCATION OF 600A, 480V SERVICE ENTRANCE CIRCUIT BREAKER & METER

EXISTING 300 KVA TRANSFORMER

EXISTING SWITCHBOARD WITH (2) PG&E SERVICE METERS

**1** EXISTING UTILITY SERVICE AREA  
EP41 SCALE: NTS

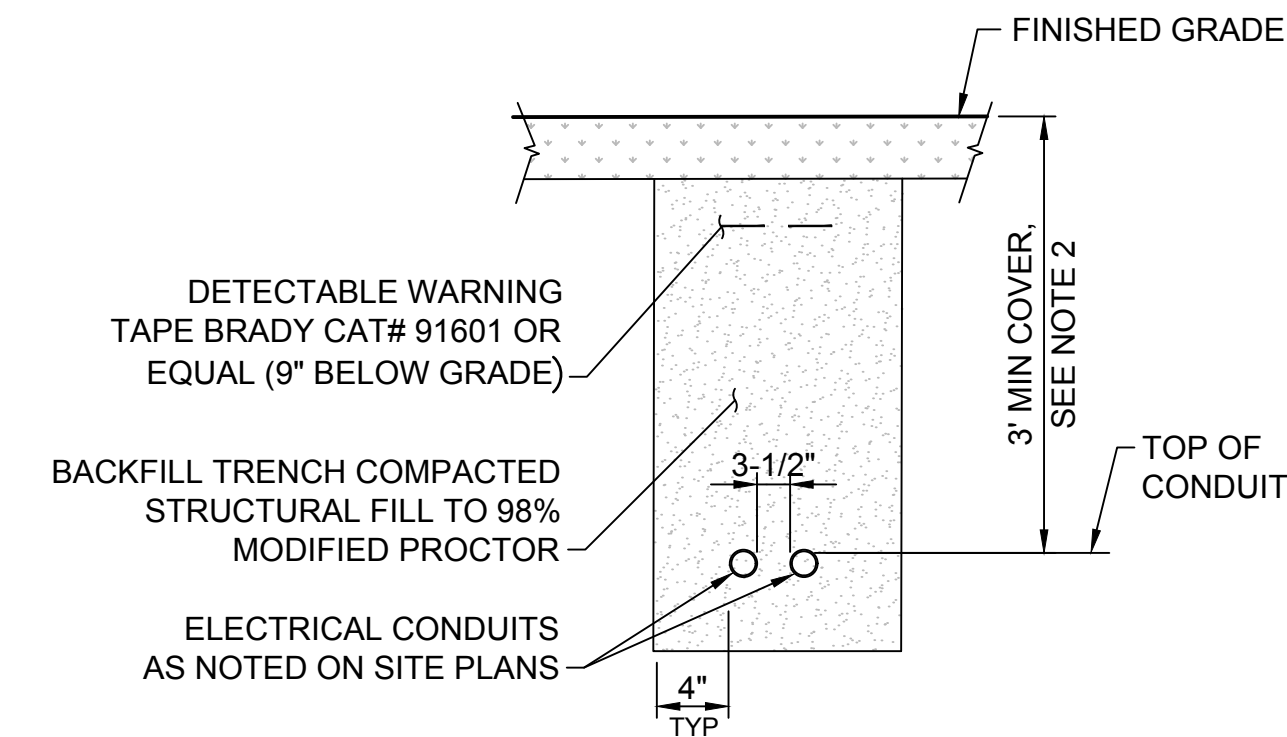

**NOTES:**

- REFER TO PLAN LAYOUTS AND CABLE SCHEDULE FOR CONDUIT/CIRCUIT TYPE, QUANTITY, AND DUCTBANK STYLE.
- 36" MINIMUM DEPTH, EXACT DEPTH TO BE COORDINATED WITH CIVIL, STRUCTURAL, AND EXISTING CONDITIONS. DEPTH LESS THAN 36" TO BE APPROVED BY ENGINEER.
- PROVIDE 36" MINIMUM COMPACTED BACKFILL COVER OF ALL DUCTBANKS AND UNDERGROUND CONDUIT.

**A** SECTION - UNDERGROUND CONDUIT DETAIL  
EP01 SCALE: NTS

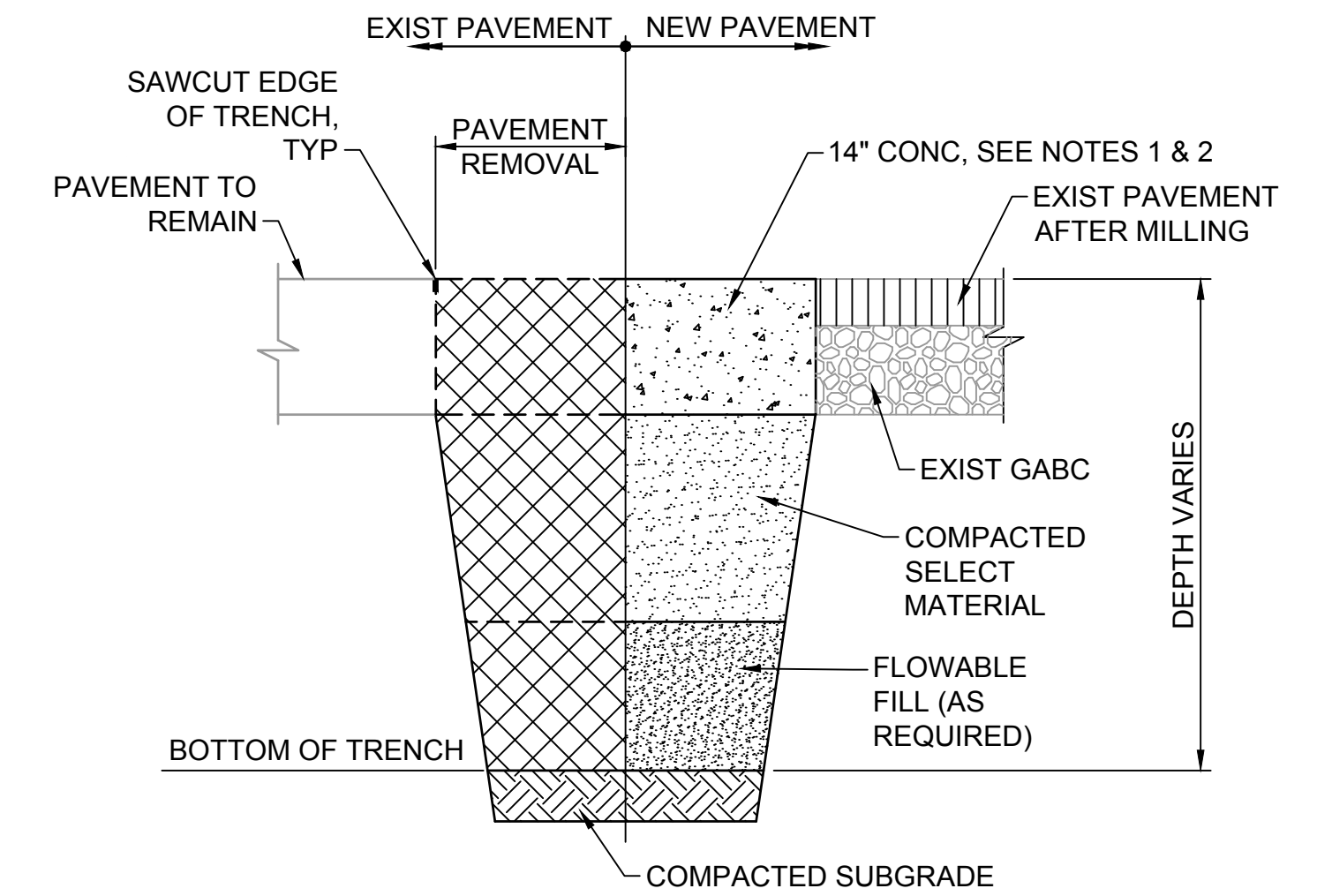

**NOTES:**

- TOP OF CONCRETE TO MATCH TOP OF EXISTING PAVEMENT. PAVEMENT REPAIR SHALL BE USED FOR TRENCHING AND OVER VAULTS.
- CONCRETE SHALL BE IN ACCORDANCE WITH SPECIFICATIONS SECTION 03300.

**3** DETAIL - TRENCH CUT REPAIR  
EP01 SCALE: NTS



EXISTING 300 KVA TRANSFORMER

EXISTING BELOW GRADE TRANSFORMER

**2** EXISTING BELOW GROUND TRANSFORMER  
EP41 SCALE: NTS

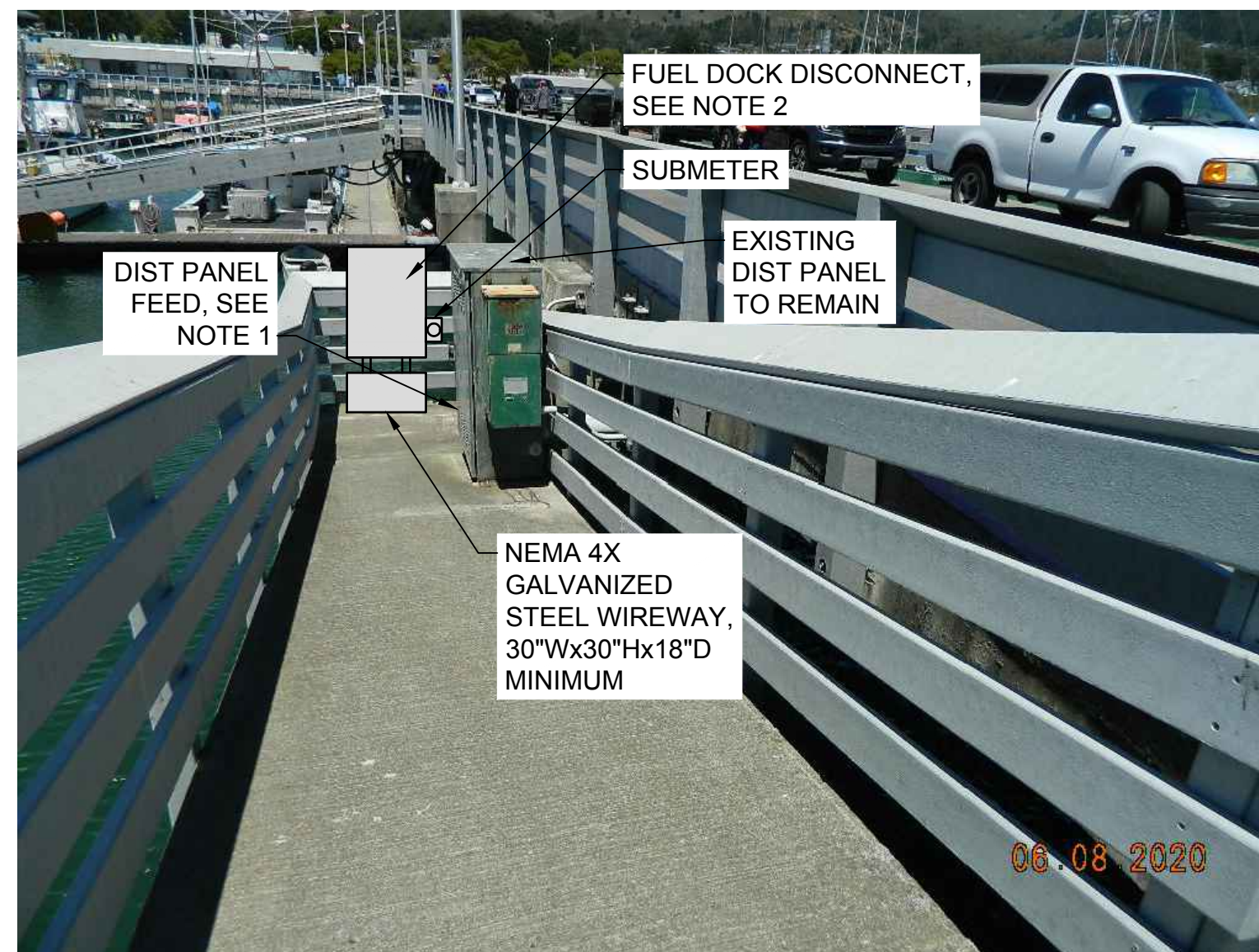

FUEL DOCK DISCONNECT, SEE NOTE 2

SUBMETER

EXISTING DIST PANEL TO REMAIN

DIST PANEL FEED, SEE NOTE 1

NEMA 4X GALVANIZED STEEL WIREWAY, 30"Wx30"Hx18"D MINIMUM

06.08.2020

**NOTES:**

- CAPTURE EXIST DIST PANEL FEEDER AND EXTEND TO WIREWAY.
- LOCATE DISCONNECT TO PROVIDE ADEQUATE WORKING SPACE. PROVIDE GALVANIZED STEEL CHANNEL STRUT MOUNTING SYSTEM.

**4** DISTRIBUTION PANEL AREA  
EP41 SCALE: NTS

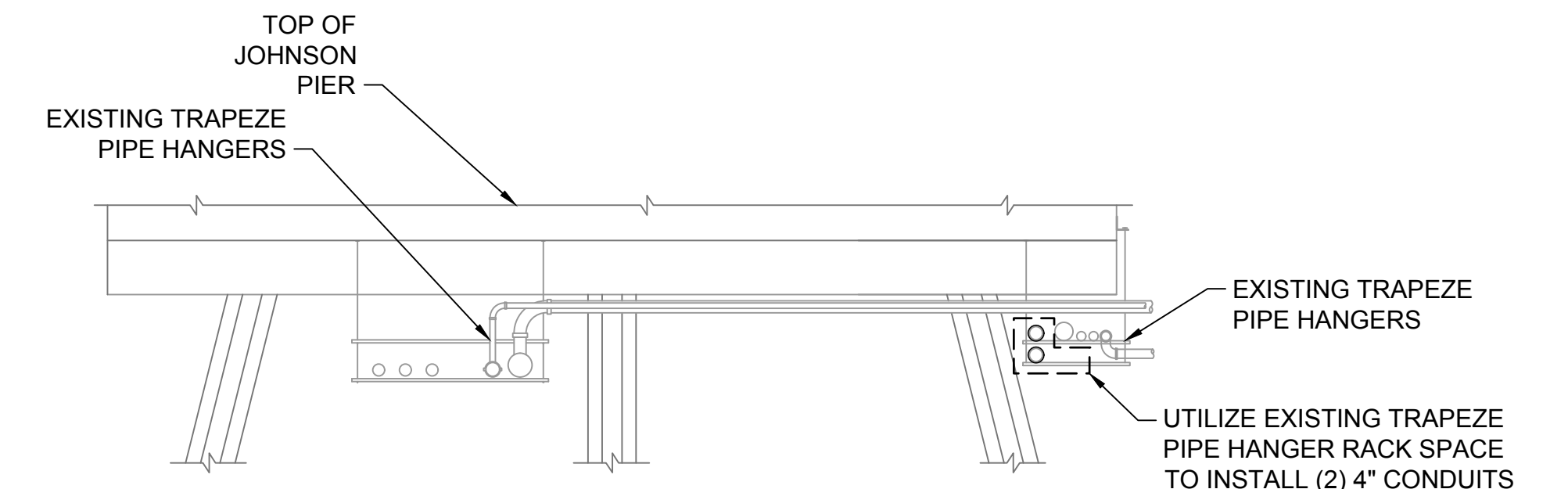

**NOTE:**

- UTILITY LAYOUT SHOWN IS SCHEMATIC ONLY. CONTRACTOR SHALL FIELD VERIFY EXISTING UTILITIES

**B** SECTION - CONDUIT INSTALLATION DETAIL  
EP01 SCALE: NTS



SAN MATEO COUNTY HARBOR DISTRICT  
504 Avenue Alhambra, 2nd Floor  
El Granada, CA 94018  
(650) 741-9163

REVISION	DESCRIPTION	BY	DATE



		2185 N. CALIFORNIA BLVD. SUITE 500 WALNUT CREEK, CA 94596	
DSGN	DJS	DR	DLA
CHK	TS	TITLE PROJECT MANAGER	
JOB NO.	9673-09	SUBMITTED BY	BRAD PORTER

SAN MATEO COUNTY HARBOR DISTRICT  
JOHNSON PIER ELECTRIC UPGRADES

DATE 4-9-2024

SHEET 7 OF 8

ELECTRICAL DETAILS (2 OF 2)

EP52



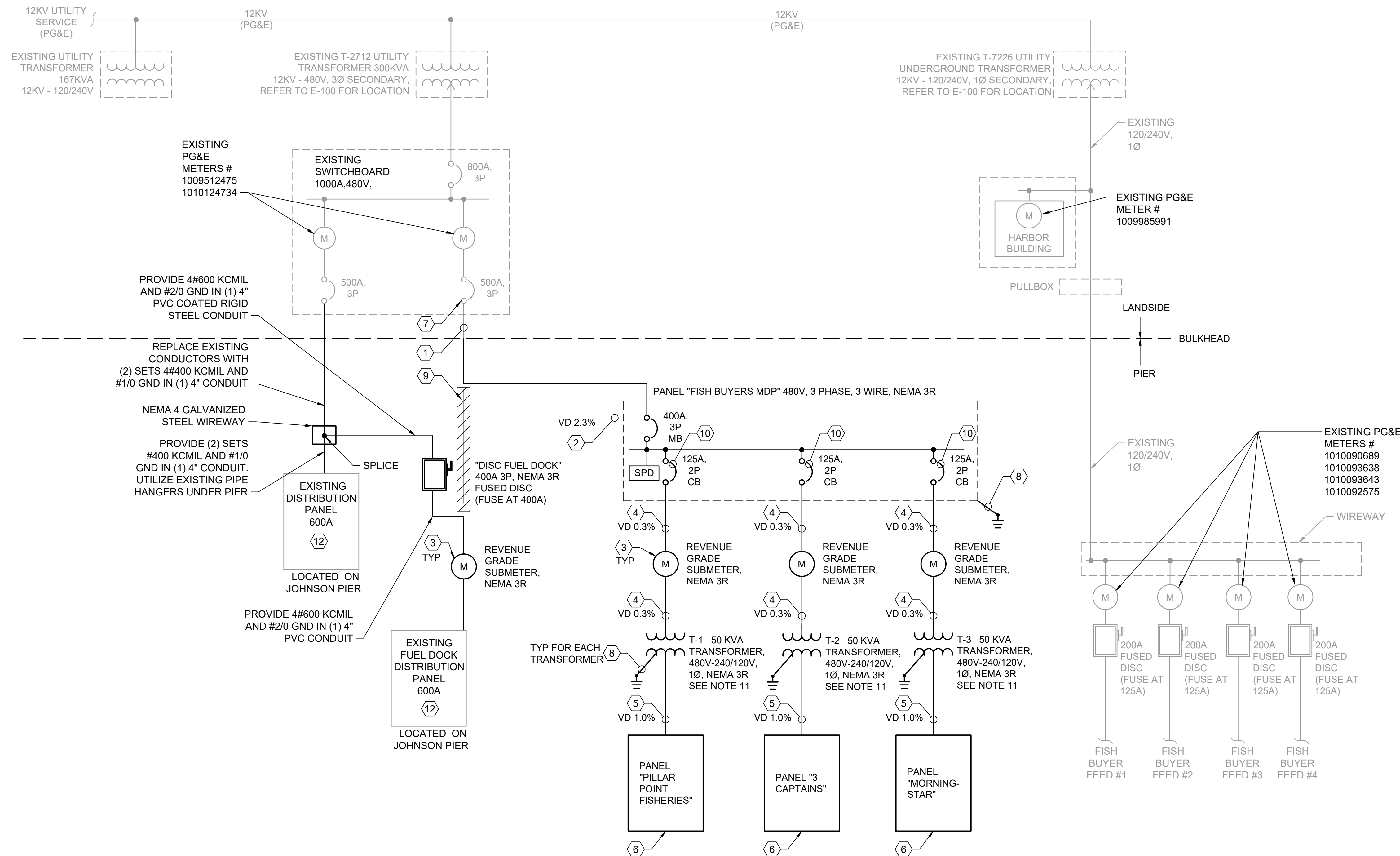

**GENERAL NOTES:**

1. ALL WORK SHALL COMPLY WITH THE LATEST EDITION OF THE NATIONAL ELECTRICAL CODE AND ALL OTHER APPLICABLE FEDERAL STATE AND LOCAL CODES. WHERE THE PLANS SHOW MORE RESTRICTIVE REQUIREMENTS, THE PLANS SHALL GOVERN. NOTHING ON THESE PLANS SHALL BE INTERPRETED AS AUTHORITY TO VIOLATE ANY CODE OR REGULATION.
2. COORDINATE ALL CONNECTION TO EXISTING UTILITY TRANSFORMER WITH PG&E.
3. COORDINATE AND SCHEDULE ALL LANDSIDE WORK WITH OWNER PRIOR TO COMMENCING WORK TO MINIMIZE ELECTRICAL AND SITE DISRUPTIONS.
4. COORDINATE AND SCHEDULE ALL FISH BUYER WORK WITH ALL FISH BUYER'S PRIOR TO COMMENCING WORK TO MINIMIZE ELECTRICAL AND SITE DISRUPTIONS.
5. ALL CONDUCTORS TO BE COPPER UNLESS OTHERWISE NOTED.
6. PROVIDE ALL TERMINATION LUGS AND OTHER REQUIRED TERMINATIONS FOR ALL ELECTRICAL EQUIPMENT AS SHOWN IN THESE PLANS.
7. PROVIDE PHENOLIC LABELS (WHITE WITH BLACK LETTERS) ON ALL ELECTRICAL GEAR COMPONENTS SHOWN. COORDINATE WITH OWNER FOR EXACT NAMING CONVENTION.
8. ALL ELECTRICAL EQUIPMENT SHALL BE NEMA 3R, GALVANIZED STEEL INCLUDING WIREWAYS, UNLESS OTHERWISE NOTED. ALL PENETRATIONS TO ELECTRICAL GEAR SHALL BE BOTTOM OR SIDE ENTRY, TOP PENETRATIONS ARE PROHIBITED.

**NOTES:**

- 1 UTILIZE EXISTING TWO 4" CONDUIT BETWEEN SWITCHBOARD AND PIER. TERMINATE CONDUCTORS ON EXISTING 500A, 3P CIRCUIT BREAKER IN EXISTING SWITCHBOARD.
- 2 UTILIZE EXISTING CONDUIT AS PRACTICABLE. ASSUME NEW CONDUIT FOR PURPOSED OF BIDDING. PROVIDE (2) SETS OF 3#350 KCMIL, #1/0 GROUND, AND #3/0 GROUNDING ELECTRODE CONDUCTOR (GEC) IN (1) 4" PVC CONDUIT. BOND GEC TO SWITCHBOARD GROUND SYSTEM.
- 3 PROVIDE REVENUE GRADE SUBMETERS.
- 4 PROVIDE 2#1 AND #6 GROUND IN 1-1/2" PVC COATED RIGID STEEL CONDUIT.
- 5 PROVIDE 3#4/0 AND #6 GROUND IN 2" PVC COATED RIGID STEEL CONDUIT.
- 6 PROVIDE 200AMP MAIN BREAKER, 120/240V, 1PH, 3W, NEMA 3R PANELBOARD. BRANCH BREAKERS SHALL BE FURNISHED AND INSTALLED BY TENANTS. PREPARE PANELBOARD POLES AS EMPTY SPACES READY TO ACCEPT BOLT-ON STYLE CIRCLE BREAKERS.
- 7 SET "AMPERE SETTING CONTINUOUS" TO 400A (DIAL SETTING 0.8X).
- 8 PROVIDE #3/0 GROUNDING ELECTRODE CONDUCTOR (GEC). COMBINE (3) TRANSFORMERS GEC USING EXOTHERMIC WELD INTO SINGLE #3/0 AND ROUTE IN FEEDER CIRCUIT BACK TO LANDSIDE SWITCHBOARD. CONNECT GEC TO SWITCHBOARD GROUNDING SYSTEM.
- 9 REMOVE UNUSED CONDUIT AND CONDUCTORS BETWEEN BASE OF PIER AND EXISTING FUEL DOCK DISTRIBUTION PANEL.
- 10 PROVIDE PROVISIONS FOR LOCKING CIRCUIT BREAKERS IN THE "OPEN" POSITION.
- 11 PROVIDE SIGNAGE STATING: TRANSFORMER FEED FROM PANEL "FISH BUYERS MDP" ON SOUTH SIDE OF BUILDING.
- 12 PROVIDE SIGNAGE STATING: 500A FEEDER BREAKER IS LOCATED IN EXISTING SWITCHBOARD. BEFORE ADDING ADDITIONAL LOADS, CHECK COMBINED LOADS FOR EXISTING DISTRIBUTION PANEL AND EXISTING FUEL DOCK DISTRIBUTION PANEL NOT TO EXCEED 500A.

**DEMAND CALCULATION**

LOAD	KVA	AMPS @ 480V, 3PHASE
EXISTING LOAD #1	87 KVA	105 A
EXISTING LOAD #2	90 KVA	108 A
NEW LOAD	150 KVA	180 A
<b>TOTAL LOAD</b>	<b>327 KVA</b>	<b>393 A</b>



**SAN MATEO COUNTY HARBOR DISTRICT**  
 504 Avenue Alhambra, 2nd Floor  
 El Granada, CA 94018  
 (650) 741-9163

REVISION	DESCRIPTION	BY	DATE



**moffatt & nichol**  
 2185 N. CALIFORNIA BLVD.  
 SUITE 500  
 WALNUT CREEK, CA 94596

DSGN: **DJS** DR: **RJC** CHK: **KK**  
 JOB NO. 9673-09 SUBMITTED BY: **BRAD PORTER** TITLE: **PROJECT MANAGER**

**SAN MATEO COUNTY HARBOR DISTRICT**  
 JOHNSON PIER ELECTRIC UPGRADES

DATE: 4-9-2024  
 SHEET: 8 OF 8

**SINGLE LINE DIAGRAM**  
**EP61**

File: C:\Users\jmorris\OneDrive\Documents\Projects\Johnson Pier\Johnson Pier\Johnson Pier.dwg, 4/11/2024 8:48 AM by: jcmw

## SECTION 01000

### SUMMARY OF WORK

#### PART 1 - GENERAL

The Contractor shall accept the site “as-is” and shall be deemed to have inspected the site and reviewed all drawings, reports and documents applicable to this work prior to submitting a bid.

#### 1.1 SCOPE OF WORK

- A. The work shall include all labor, materials, tools, equipment, supervision, coordination efforts, taxes, contractor permitting costs, services, security, insurance and all other associated or related items specified herein that are necessary and required to complete the Johnson Pier Expansion and Dock Replacement. Work consists of the following:
1. Remove terminations of the existing Fuel Dock Distribution Panel feeders from existing Landside Service Entrance Switchboard. Intercept existing Johnson Pier Distribution Panel service feeders located on Johnson Pier and extend to new wireway adjacent to Johnson Pier Distribution Panel on pier. Splice into captured Johnson Pier Distribution Panel feeder at new wireway for new feed to Existing Fuel Dock Distribution Panel and re-feed of existing Johnson Pier Distribution Panel. Provide new disconnect and revenue meter for Fuel Dock Distribution Panel feeder/service. Route feeders for existing Fuel Dock Distribution Panel under pier.
  2. Utilize circuit breaker in existing Landside Service Entrance Switchboard, made spare from termination removals of Existing Fuel Dock Distribution Panel service, and provide feed to a new 480V panel located adjacent to the Fish Buyer Building. Route feeder under pier. Provide three revenue meters, transformers, and disconnects located adjacent to Fish Buyer Panel. Continue conduit into Fish Buyer Building for future vendor panels installed by others.
- B. Supporting images are located in the contract drawings. The work shall include, but shall not be limited to the following:
1. Secure required permits
  2. Items listed in accordance with scope
  3. Leave grounds clear of all debris resulting from work
  4. Contractor shall maintain public safety throughout project construction period
  5. At the end of each working day, Contractor shall ensure all systems of the business are in full operation.
  6. Staging of project shall be completed in order to minimize negative impacts on business

#### 1.2 REFERENCE STANDARDS AND DOCUMENTS

- A. All work to conform to all applicable San Mateo County Building Codes and accepted professional standards. All materials shall conform to applicable standards.

- B. All applicable Federal and State Occupational Safety and Health Administration (OSHA) requirements and other Federal, State and San Mateo County Harbor District codes, laws, ordinances, regulations, and guidelines for demolition and related work.
- C. Building Officials and Code Administrators (BOCA) and/or City Building Code, latest edition.

### 1.3 DEFINITIONS

- A. The following definitions apply to this specification:
  - 1. Owner: San Mateo County Harbor District (“the District”)
  - 2. Contractor: The successful awarded bidder for this Contract.
  - 3. Governing Authorities or Agencies: Any and all Federal, State, County or City authorities or entities having jurisdiction over any part, method, procedure, operation or other element pertaining to work and/or this Contract.

### 1.4 QUALITY ASSURANCE

- A. The Contractor shall comply with the requirements of all applicable Federal, State, and local safety and health regulations regarding the demolition and construction of structures including ANSI/NFPA 241 – Standard for Safeguarding Construction, Alteration, and Demolition Operations
- B. The Contractor shall preserve and protect existing adjacent structures at all times. He shall be responsible for any damage to any adjacent structures to remain.
- C. The Contractor shall perform all quality assurance sampling and testing as specified. Testing shall be performed by an Independent Testing Laboratory (ITL) selected by the Contractor and approved by the District. Submit company contact information, names of personnel to perform quality assurance testing, and proof of Certifications for the quality assurance tests to be performed.

### 1.5 SUBMITTALS

- A. Schedule
  - 1. No later 10 days after the notice to proceed the Contractor shall submit to the Owner the proposed demolition and construction means, methods, and procedures including a detailed operational sequence complete with starting and ending dates for each activity prior to start of work for approval.
- B. Permits
  - 1. Prior to commencement of work, the Contractor shall obtain and submit copies of all necessary permits and certificates associated with utility disconnections, and site and building demolition/construction work from any and all Federal, State, County and City authorities having jurisdiction over the project. The Contractor shall incur all fees and other requirements associated with obtaining the required permits and certificates.
  - 2. Permits for the project have been applied for by the Owner and will be issued by the following regulatory agencies:
    - a. California Coastal Commission (CCC) – Coastal Development Permit

- b. San Francisco Bay Regional Water Quality Control Board (RWQCB) – Section 401 Water Quality Certification and Waste Discharge Requirements
  - c. U.S. Army Corp of Engineers (Corps) – Individual Permit
3. Changes in Permit Conditions: Contractor acknowledges that the Work includes services not provided under specific Bid Items that are reasonably necessary to comply with permit conditions. In the event that an additional permit necessary for the performance of the Work is issued, or an existing permit is modified, after the Bid Submission date, the Contractor recognizes the terms, conditions and requirements of such permit or modification may require the Contractor to perform services or to provide services or to provide materials which are different from the Work contained in the Contract Documents. In such event, the Contractor shall not be entitled to any adjustment in the Contract Sum or Contract Terms unless such change in the Work materially differs from the Work in the Contract Documents and such change could not be reasonably expected by the Contractor given the ordinarily encountered and generally recognized implementation of similar permits. Contractor shall be responsible for its cost of evaluating the implications for the Work of the terms, conditions and restrictions of the permits, and of responding to any Requests for Proposals or Field Changes of the Owner which are issued in connection with the issuance of the permit(s).

C. Other

1. Submit a written request to the Owner a minimum of 10 days prior to executing any cutting or alteration that affects:
  - a. Existing operational systems of the facility including electrical, mechanical and security systems.
2. The Contractor shall meet with the Owner to discuss traffic and parking impacts, as adjacent property owners and users may be impacted.
3. Submit written notification to the Owner for approval by the Owner to proceed if during demolition/construction the conditions are discovered which significantly vary from those shown in the Contract Documents.

## 1.6 SITE AND BUILDING DESCRIPTIONS

A. General Information

1. The existing building, structures, and vegetation within the project area are shown in associated supporting images located in the contract drawings.

B. Qualifications

1. The Contractor shall visit the site to determine the actual details of the existing site to be worked on.

## 1.7 PROJECT MEETINGS

- A. Contractor to participate in a project meeting with Owner prior to commencing demolition/construction. The goal of this meeting is to coordinate Contractor's planned schedule and methods with the Owner to minimize disruption to adjacent facilities.

## 1.8 OCCUPANCY

- A. Pillar Point and Johnson Pier will continue to operate and function as usual while the work is in progress. The buildings and facilities adjacent to the site shall also continue to operate and function. Public access at Johnson Pier and all other docks of Pillar Point Marina shall remain open. As such, the Contractor shall take any and all measures necessary to protect persons associated with these businesses and the public in general, from harm and damage during demolition/construction activities, as well as maintaining vehicle and pedestrian traffic around the project area.

## 1.9 CONDITIONS OF STRUCTURES

- A. A pre-bid inspection of the site will be scheduled by the Owner to familiarize prospective bidders with site conditions. The inspection will include a walk-through of the building as well as the entire site followed by a question and answer period.
- B. Conditions existing at the time of inspection for bidding purposes will be maintained by the Owner insofar as practicable. The Contractor's bid affirms the acceptance of the site, building and its interior "as-is" on the date of contract award unless specifically otherwise stated by the Owner at the pre-bid inspection.

## 1.10 Traffic

- A. The Contractor shall conduct demolition/construction operations and removal of debris in a manner that ensures the least interference with streets, pedestrian walkways, and on-site occupied buildings or facilities.

## 1.11 PROTECTION AND SAFETY

- A. Protection and safety of adjacent businesses and of surrounding properties shall take the highest priority during demolition/construction operations. All operations shall be conducted so as to prevent damage to adjacent building, appurtenant structures and facilities, and injury to persons.
- B. The Contractor shall make a careful examination of the structures to be replaced, and of the structures and utilities in close proximity which are to remain and shall take whatever precautions are necessary to carry on operations so as to prevent any settlement, collapse, or destruction of existing structures, paving, sidewalks, utilities and other existing features that are to remain. During all operations, the Contractor shall be responsible for the structural integrity of these structures and surrounding structures relative to any problems or damages resulting from the performance of the Contractor's work. The Contractor shall notify the Owner immediately if the safety of an on-site structure or facility is endangered or if any change has occurred. Any damage inflicted upon adjacent property, construction or utilities, by the Contractor's work shall be corrected promptly by the Contractor, at his sole cost and expense.
- C. The Contractor shall be responsible for executing the work in a manner that is safe for his workers and persons in and around the job site and shall ensure free and safe passage of the persons around the area of demolition/construction. Any possible hazards resulting from demolition/construction activities shall be corrected prior to continuation of work in that specific area. The Owner reserves the right to stop work at any time in cases where the safety of the Contractor's operation is in question or is in conflict with the Contract Specifications.

1.12 SECURITY

- A. The Contractor shall be solely responsible for maintaining security at the project site at all times and shall coordinate with the Owner access to the Owner's property and adjacent areas.

1.13 TEMPORARY SERVICES AND FACILITIES

- A. The provision of temporary water, electricity, exterior lighting, phone lines and all other services and facilities for demolition/construction operations shall be the responsibility of the Contractor. The Contractor shall also provide all necessary services and facilities as require by Federal, State and City applicable regulations, and shall contact the appropriate utility companies to arrange for connections and permits. The Contractor shall pay all necessary fees for connection, metering, utility charge, and disconnection without charge to the Owner.
- B. The Contractor shall provide and maintain a capable and experienced field person representing the Contractor to oversee all demolition/construction operations. The representative shall be on site during all operating hours of the project. The Contractor's representative shall be approved by the Owner.
- C. If fire protection needs are not supplied by permanent facilities, the Contractor shall in accordance with applicable Federal, State and City requirements, install and maintain temporary fire protection facilities in compliance with such requirements, and at a minimum in accordance with National Fire Protection Association, NFPA 241 "Standard for Safeguarding."

1.14 WORKING HOURS

- A. The Contractor shall limit all work for the project to the hours of 7AM to 5 PM, Monday through Friday. Subject to approval by the Owner, Contractor may request to work hours outside of this window.

1.15 LIMIT OF WORK

- A. Refer to the Project Scope for the limit of demolition/construction work.

1.16 UNACCEPTABLE PERFORMANCE

- A. The Contractor shall remove from the project any individual employed by the Contractor who is performing work in an unacceptable manner as determined by the Owner. The Contractor shall not be allowed claims for delays or down time resulting from the removal of such employees.
- B.

## PART 2 - PRODUCTS – NOT USED

## PART 3 - EXECUTION

### 3.1 TRAFFIC

- A. Prior to commencement of demolition/construction operations, the Contractor shall implement all vehicular and/or pedestrian traffic protection measures indicated on their Traffic Control Plan, as well as any other measures required by the City governing authorities before, during, and after the project.

### 3.2 TEMPORARY EXTERIOR LIGHTING

- A. If required by permit or code, the Contractor shall furnish and install exterior security lighting of the work area for the duration of the project. Site lighting locations shall be as approved by the Owner.
- B. If required, the Contractor shall furnish and install a temporary electric service for the site security lighting and shall provide all lines, connections, grounds and any other necessary or required items for the lighting system installation and maintenance. The Contractor shall remove this lighting upon completion of the demolition/construction activities unless otherwise directed by the Owner.
- C. The installation of exterior security lighting shall in no way remove Contractor responsibility for installing additional lighting, inside buildings or out, as required by Federal, State or City governing authorities for the performance of safe demolition work.

### 3.3 UTILITIES

#### A. General

- 1. It shall be the Contractor's responsibility to determine the actual location of all utility connections. The Contractor shall maintain utilities which are to remain during the progress of his work. The Contractor shall promptly repair or have repaired by applicable utility company any damage incurred to utilities during demolition/construction work at his sole cost and expense.
- 2. The Contractor shall maintain and protect from damage all existing utilities that are to remain. The Contractor shall immediately repair or have repaired by the appropriate utility company any damage incurred by utilities during demolition/construction work at no cost to the Owner or City. The Contractor shall be responsible for notifying and coordinating with the appropriate utility companies the shut-off of utilities.

#### B. Shut-off Notifications

- 1. The Contractor shall be responsible for notifying any applicable utilities regarding the shut off of any services and shall provide owner with written confirmation from the utility company that service has been terminated prior to the start of demolition/construction.

#### C. Interruption of Existing Service

1. Existing utility services shall not be interrupted unless authorized in writing by authorities having jurisdiction and the Owner of the utility. Any temporary interruption necessary shall be directly coordinated and supervised by utility company personnel. The Contractor shall provide temporary services during interruptions to existing utilities, as acceptable to governing authorities and the affected utility companies.

D. Disconnection and Removal

1. The Contractor shall disconnect and cap/terminate all services including but not limited to, water, sewers, electric, telephone, etc. as needed for demolition/construction work. The Contractor shall identify all services and determine if utility laterals to be demolished are direct and exclusive before disconnection is performed.
2. Prior to removal, all utilities and sewers shall be properly purged and evacuated of all residual gases, waste, debris, etc. or de-energized in the case of electric, telephone or other communication services. All purging and testing shall be approved by local utility or sewer companies and governing authorities having jurisdiction.
3. The Contractor or appropriate utility or sewer company (if required) shall seal and/or plug the ends of all disconnected utilities for the demolition/construction work as recommended and required by the utility or sewer company. All plugs may be inspected by the appropriate utility or City agency or department.

3.4 DEMOLITION

A. General

1. The Contractor shall coordinate with the Owner and the State, County, City regulatory authorities, as may be required, on the method of demolition. Said method shall be specifically approved by the Owner.
2. Demolished materials (explain approved process for disposal)
3. Contractor shall take ownership of all demolished materials and may either salvage or dispose of such materials.
4. Hazardous Waste Contingency: In the event the Contractor encounters previously unidentified material that is reasonably believed to be hazardous, asbestos containing, coated with lead-based paint, or oily debris, the Contractor shall immediately stop work in the affected area and report the condition to the Owner. The Contractor agrees to provide a plan to appropriately remove and dispose of the hazardous materials.

END OF SECTION 01000



SECTION 01100

DEFINITION OF BID ITEMS

PART 1 - GENERAL

1.1 SUMMARY

- A. The intent of this section is to clarify, in general, what is and what is not included in a bid item, and the limits or cut-off points where one bid item ends and another begins. If no bid item exists for a portion of the work, include the costs in a related bid item. Measurement and Payment for all items of work shall be done in accordance with Section 01200 "Measurement and Payment." The lump sum or unit price for each item shall be full compensation for all labor, materials, equipment, tools, and incidentals to complete each bid item.

1.2 BID ITEM NO. 1 – MOBILIZATION, DEMOBILIZATION, BONDS & INSURANCE

- A. This bid item consists of mobilization and demobilization in accordance with the State of California Department of Transportation (Caltrans) Standard Specifications. This bid item includes mobilization of equipment, materials and personnel; temporary facilities; temporary fencing; preparation of submittals; and demobilization.
- B. Unit of Payment: Lump Sum (LS)

1.3 BID ITEM NO. 2 – JOHNSON PIER DIST PANEL FEEDER/SERVICE RECONFIGURATION

- A. This bid item consists of intercepting existing Johnson Pier Distribution Panel service feeders along Johnson Pier and extend conduit and conductors to new wireway located adjacent to existing Johnson Pier Distribution Panel on pier. Provide wireway, conduit and conductors as identified on drawings.
- B. Unit of Payment: Lump Sum (LS)

1.4 BID ITEM NO. 3 – FUEL DOCK DIST PANEL FEEDER/SERVICE RECONFIGURATION

- A. This bid item consists of splicing into captured Johnson Pier Distribution Panel feeder at new wireway, as described in Bid Item No.1, for new feed to Existing Fuel Dock Distribution Panel. Provide new conductors, conduit, disconnect, revenue meter for Fuel Dock Distribution Panel feeder/service as indicated on drawings. Route feeders for existing Fuel Dock Distribution Panel under pier.
- B. Unit of Payment: Lump Sum (LS) with line items for Fuel Disconnect and Revenue Grade Submeter

1.5 BID ITEM NO. 4 – FISH BUYER SERVICE FEEDER

- A. This bid item consists of utilizing circuit breaker in existing Landside Service Entrance Switchboard, made spare from rework of Existing Fuel Dock Distribution Panel service. Provide feed to a new 480V panel located adjacent to the Fish Buyer Building. Route feeder under pier as indicated on the drawings. This bid item to include conductors, conduit, penetration thru pier, grounding electrode conductor to landside, and additional conduit supports under pier.
- B. Unit of Payment: Lump Sum (LS)

1.6 BID ITEM NO. 5 – FISH BUYER 480V PANELBOARD

- A. This bid item consists of furnishing and installing new 480V panel located adjacent to the Fish Buyer Building complete in place as shown on the Drawings. This bid item to include secondary conduit, conductors, and grounding.
- B. Unit of Payment: Lump Sum (LS) with line item for 480V panelboard

1.7 BID ITEM NO. 6 – FISH BUYER REVENUE GRADE SUBMETERS

- A. This bid item consists of furnishing and installing (3) new revenue meters for Fish Buyer Distribution Panel feeder/service as indicated on drawings.
- B. Unit of Payment: Lump Sum (LS)

1.8 BID ITEM NO. 7 – FISH BUYER 50KVA TRANSFORMERS

- A. This bid item consists of furnishing and installing (3) new transformers for Fish Buyer Distribution Panel feeder/service as indicated on drawings.
- B. Unit of Payment: Lump Sum (LS)

1.9 BID ITEM NO. 8 – FISH BUYER SERVICE DISCONNECTS AND ASSOCIATED CONDUIT/WIRE

- A. This bid item consists of furnishing and installing (3) new disconnects for Fish Buyer Distribution Panel feeder/service as indicated on drawings. This bid item to also included secondary conduit and conductors from transformer to adjacent disconnects as indicated on drawings. In addition, provide penetration of empty conduit into Fish Buyer Building for future vendor panels installed by others.
- B. Unit of Payment: Lump Sum (LS) with line item for disconnects

PART 2 - PRODUCTS – NOT USED

PART 3 - EXECUTION – NOT USED

END OF SECTION 01100

## SECTION 01200

### MEASUREMENT AND PAYMENT

#### PART 1 - GENERAL

##### 1.1 SUMMARY

- A. This Section describes requirements and procedures for determining amount of work performed and for obtaining payment for work performed. This Contract included Work covered by both lump sum and unit prices.

##### 1.2 DETERMINATION OF QUANTITIES

- A. Quantity of the work to be paid for under any item for which a unit price is fixed in the Contract Documents shall be the number, as determined by the District, of units of work satisfactorily completed in accordance with Contract Documents or as directed by the District. Unless otherwise provided, determination of number of units of work so completed will be based, so far as practicable, on actual measurement or count within prescribed or ordered limits, and no payment will be made for work done outside of limits. Measurements and computations will be made by methods as the District may consider appropriate for class of work measured. Contractor shall immediately inform the District of any disputes regarding quantity measurements, and shall immediately supply the District with any documentation supporting such disputed measurements.
- B. For material specified to be paid for by the linear foot, the unit shall be measured on a horizontal plane.
- C. For material specified to be paid for by the square foot or square yard, the unit shall be measured on the horizontal plane surface area.
- D. For material specified to be paid for by each, the unit shall be measured by number of individual units.
- E. Material specified to be measured and paid for by volume will be inspected, estimated and recorded by the District for comparison with quantities submitted with requests for payment.

##### 1.3 SCOPE OF PAYMENT

- A. Payment to the Contractor at the unit price or other price fixed in the Contract for performing the Work required under any item, or at the lump sum price fixed in the Contract for performing all work required under the Contract Documents, and as either may be adjusted pursuant to any approved Change Order, shall be full compensation for completing, in accordance with the Contract Documents, all Work required under the item or under the Contract Documents, and for all expense incurred by the Contractor for any purpose in connection with the performance and completion of said Work, including all incidental work necessary for completion of the Work.
- B. The Contract Sum, which includes both lump sum and unit price, shall be deemed to include all costs necessary to complete the required Work, individual Work item or unit price item, and shall

also include any costs for loss or damage arising from nature of Work or, prosecution of the Work, or from action of elements. Unless the Contract Documents expressly provide otherwise, the Contract Sum and each individual bid item and unit price item, respectively, shall be deemed to include:

1. Any and all costs which may arise from any unforeseen difficulties encountered during, and all risks of any description connected with, prosecution of work, bid item or unit price item, respectively, until acceptance by the District;
  2. All expenses which may be incurred due to suspension, or discontinuance of Work, bid item or unit price item, respectively, as provided in the Contract Documents;
  3. Escalation to allow for cost increases between time of Contract Award and completion of Work, bid item or unit price item, respectively.
- C. Whenever it is specified herein that the Contractor is to do work or furnish materials of any class for which no price is fixed in the Contract Documents, it shall be understood that the Contractor is to do such work or furnish such materials without extra charge or allowance or direct payment of any sort, and that cost of doing work or furnishing materials is to be included in price bid, unless it is expressly specified herein, in particular cases, that work or material is to be paid for as extra work.
- D. No payment shall be made for materials or equipment not yet incorporated into the Work.
- E. For the materials and equipment referenced as subject to payment prior to incorporation into the Work, where the Contractor requests payment on the basis of such materials and equipment not incorporated in the Work, the Contractor must satisfy the following conditions:
1. The materials and/or equipment shall be delivered and suitably stored at the site or at another local location agreed to in writing, for example, a mutually acceptable warehouse;
  2. Full title to the materials and/or equipment shall vest in the District at the time of delivery to the site, warehouse or other storage location;
  3. Stockpiled materials and/or equipment shall be available for the District's inspection, but the District shall have no obligation to inspect them and its inspection or failure to inspect shall not relieve the Contractor of any obligations under the Contract Documents. Materials and/or equipment shall be segregated and labeled or tagged to specifically identify this specific Contract Documents;
  4. After delivery of materials and/or equipment, if any inherent or acquired defects are discovered, defective materials and/or equipment shall be removed and replaced with suitable materials and/or equipment at the Contractor's expense;
  5. At its expense, the Contractor shall insure the materials and/or equipment against theft, fire, vandalism, and malicious mischief, as well as any other coverage's required under the Contract Documents;
  6. The Contractor's application for payment shall be accompanied by a bill of sale, invoice or other documentation warranting that the District has received the materials and equipment free and clear of all liens and evidence that the materials and equipment are covered by appropriate property insurance and other arrangements to protect the District's interest therein, all of which must be satisfactory to the District. This documentation shall include, but not be limited to, conditional releases of mechanics' liens and stop notices from all those providing materials and equipment as to which the application for payment relates, as well as unconditional releases of the same from the same as to the previous applications for payment for which they have not already been provided.

#### 1.4 BASIS OF PAYMENT

- A. Unit Pay Quantities: When estimated quantity for specific portions of Work is listed in Bid Form, Quantity of work to be paid for shall be actual number of units satisfactorily completed in accordance with Contract Documents.
- B. Lump Sum: When estimated quantity for specific portion of Work is not indicated and unit is designated as Lump Sum, payment will be on a Lump sum basis for Work satisfactorily completed in accordance with Contract Documents.
- C. The District does not expressly, or by implication, agree, warrant, or represent in any manner, that actual amount of Work will correspond with amount shown or estimated and reserves right to increase or decrease amount of any class or portion of Work, to leave out entire Bid Item or Items, or to add Work not included in Bid, when in its judgment such change is in best interest of the District. No change in work shall be considered waiver of any other condition of the Contract Documents. No claim shall be made for anticipated profit, for loss of profit, for damages, or for extra payment whatever, except as otherwise expressly provided for in the Contract Documents, because of any differences between amount of Work actually done and estimated amount as set forth herein, or for elimination of extra Bid Items.
- D. Notwithstanding the above provisions, the unit prices set forth in the Bid Form shall be utilized where they are applicable. If the Contract Change Order increases or decreases the quantity of an item of work by more than twenty-five percent (25%), such that the application of unit prices in the Bid will cause substantial inequity of the District or Contractor, unit prices will be adjusted as follows:
  - 1. Increases of More Than 25 Percent. If the total pay quantity of work required under the Contract exceeds the estimated quantity set forth in the Bid therefore by more than 25 percent, no adjustment in unit price will be made unless the District or the Contractor so requests in writing not later than fifteen (15) days after substantial completion of the subject item of work. Such adjustment of the unit price will be the difference between the contract unit price and the actual unit cost of the total pay quantity of the item. If the costs applicable to such item of work include fixed costs, such fixed costs will be deemed to have been recovered by the Contractor by the payments made for 125 percent of the estimated quantity set forth in the Bid for such item, and in computing the actual unit cost, such fixed costs will be excluded.
  - 2. Decreases of More Than 25 Percent. If the total pay quantity of any item of work required under the Contract is less than 75 percent of the estimated quantity set forth in the Bid therefore, but the item of work is not entirely eliminated, an adjustment in unit price pursuant to this paragraph will not be made unless the Contractor so requests in writing not later than fifteen (15) days after substantial completion of the subject item of work. Such adjustment of the contract unit price will be the difference between the contract unit price and the actual unit cost. The payment for the total pay quantity of such item of work shall in no case exceed the payment which would be made for the performance of 75 percent of the estimated quantity set forth in the Bid for such item at the contract unit price.

#### 1.5 PROGRESS PAYMENTS

- A. If requested by the Contractor, progress payments will be made monthly.

B. Payment Requests

1. Unless otherwise agreed, Contractor shall submit to the District, on or before the fifth (5th) day of each month, electronic (pdf) copy or five (5) hardcopies of a request for payment for the cost of the Work put in place during the period from the 1st day of the previous month to the 30th day of the previous month. If the Contractor is late submitting its payment request, that payment request may be processed at any time during the succeeding one-month period, resulting in processing of the Contractor's payment request being delayed for more than a day-for-day basis.
2. Payment requests may include, but are not necessarily limited to the following:
  - a. Material, equipment and labor incorporated into the Work, less any previous payments for the same;
  - b. Up to seventy-five percent (75%) of the actual cost (not bid cost) of major equipment if purchased and delivered to the site or stored off site, as may be approved by the District.
  - c. Up to fifty percent (50%) of the actual cost (not bid cost) of materials specifically fabricated for the Project that are not yet incorporated into the Work, provided such materials are located on the Site.
3. The Contractor shall, at the time any payment request is submitted, certify in writing the accuracy of the payment request.
4. No progress payment will be processed prior to the District receiving all requested, acceptable schedule update information. No progress payment will be made unless Project Record Documents are being kept up to date.
5. Each payment request shall list each Change Order executed prior to date of submission, including the Change Order Number, and a description of the Work activities, consistent with the descriptions of original Work activities. The Contractor shall submit a monthly Change Order status log to the District.
6. If the District requires substantiating data, the Contractor shall submit information requested by the District, with cover letter identifying Project, payment request number and date, and detailed list of enclosures. The Contractor shall submit one copy of substantiating data and cover letter for each copy payment request submitted.
7. The Contractor shall promptly pay each Subcontractor or Subconsultant the amount to which such Subcontractor or Subconsultant is entitled, and shall, by an appropriate agreement with each Subcontractor or Subconsultant, require each Subcontractor or Subconsultant to make payments to its Sub-subcontractors or Sub-subconsultants in a similar manner. The Contractor shall submit on its behalf and on behalf of each Subcontractor or Consultant for which payment is being requested a conditional release of mechanics' lien in statutory form for the Work which is the subject of each progress payment request and an unconditional release of mechanics' lien in statutory form for the immediately preceding progress payment as to the Work of each.

C. Progress Payments

1. Upon receiving the Contractor's payment request, the District will review the payment request and make necessary adjustments to percent of completion of each activity. One copy (electronic/pdf or hardcopy) will be returned to the Contractor with description of adjustments made. All parties will update percentage of completion values in the same manner, i.e., express value of an accumulated percentage of completion to date.
2. The payment request may be reviewed by the District and/or inspectors, for the purpose of determining that the payment request is a proper payment request, and shall be rejected,

- revised or approved by the District pursuant to the cost breakdown prepared in accordance with this Section.
3. If it is determined that the payment request is not a proper payment request suitable for payment, the District shall return it to the Contractor as soon as practicable, but no later than five (5) days after receipt, together with a document setting forth in writing the reasons why the payment request is not proper. If the District determines that portions of the payment request is not proper or not due under the Contract Documents, then the District may approve the other portions of the payment request, and in the case of disputed item or defective work not remedied, may withhold up to 150% of the disputed amount from the progress payment.
  4. As soon as practicable after approval of each request for progress payment, the District will pay to the Contractor in manner provided by law, an amount equal to ninety percent (90%) of the District's estimate, or a lesser amount if so provided in Contract Documents, provided that payments may at any time be withheld if, in judgment of the District, Work is not proceeding in accordance with the Contract Documents, or the Contractor is not complying with requirements of the Contract Documents, or to comply with stop notices or to offset liquidated damages accruing or expected.
  5. Retention will not be reduced if the Contractor, in opinion of the District is behind schedule.
  6. Before any progress payment or final payment is made, the Contractor may be required to submit satisfactory evidence that the Contractor is not delinquent in payments to employees, subcontractors, suppliers, or creditors for labor and materials incorporated into Work.
  7. Progress payment for the mobilization and demobilization of the Contractor under Bid Item for mobilization and demobilization will be paid under Section 01500 "Mobilization and Demobilization."

#### 1.6 FINAL PAYMENT

- A. As soon as practicable after all required Work is completed in accordance with the Contract Documents, including the Contractor's maintenance after Final Acceptance, the District will pay to the Contractor, in manner provided by law, unpaid balance of contract price of Work, or whole contract price of Work if no progress payment has been made, determined in accordance with terms of the Contract Documents, less sums as may be lawfully retained under any provisions of the Contract Documents or by law.
- B. Prior progress payments shall be subjected to correction in the final payment. The District's determination of amount due as final payment shall be final and conclusive evidence of amount of Work performed by the Contractor under the Contract Documents, and shall be full measure of compensation to be received by the Contractor.
- C. The Contractor and each assignee under an assignment in effect at time of final payment shall execute and deliver at time of final payment and as a condition precedent to final payment, Agreement and Release of Any and All Claims, discharging the District, its officers, agents, employees and consultants of and from liabilities, obligations, and claims arising under the Contract Documents.

END OF SECTION 01200

SECTION 16201

ELECTRICAL DISTRIBUTION SYSTEM

PART 1 GENERAL

1.1 REFERENCES

The publications listed below form a part of this specification to the extent referenced. The publications are referred to within the text by the basic designation only.

AMERICAN NATIONAL STANDARDS INSTITUTE (ANSI)

ANSI C12.1 (2014; Errata 2016) Electric Meters - Code for Electricity Metering

ASTM INTERNATIONAL (ASTM)

ASTM B1 (2013) Standard Specification for Hard-Drawn Copper Wire

ASTM B8 (2011; R 2017) Standard Specification for Concentric-Lay-Stranded Copper Conductors, Hard, Medium-Hard, or Soft

ASTM D709 (2017) Standard Specification for Laminated Thermosetting Materials

INSTITUTE OF ELECTRICAL AND ELECTRONICS ENGINEERS (IEEE)

IEEE 81 (2012) Guide for Measuring Earth Resistivity, Ground Impedance, and Earth Surface Potentials of a Ground System

IEEE 100 (2000; Archived) The Authoritative Dictionary of IEEE Standards Terms

IEEE C2 (2017; Errata 1-2 2017; INT 1 2017) National Electrical Safety Code

INTERNATIONAL ELECTRICAL TESTING ASSOCIATION (NETA)

NETA ATS (2021) Standard for Acceptance Testing Specifications for Electrical Power Equipment and Systems

NATIONAL ELECTRICAL CONTRACTORS ASSOCIATION (NECA)

NECA NEIS 1 (2015) Standard for Good Workmanship in Electrical Construction

NATIONAL ELECTRICAL MANUFACTURERS ASSOCIATION (NEMA)

ANSI C80.1 (2020) American National Standard for Electrical Rigid Steel Conduit (ERSC)

NEMA 250 (2020) Enclosures for Electrical Equipment (1000 Volts Maximum)

NEMA FU 1 (2012) Low Voltage Cartridge Fuses



NEMA ICS 1	(2000; R 2015) Standard for Industrial Control and Systems: General Requirements
NEMA ICS 6	(1993; R 2016) Industrial Control and Systems: Enclosures
NEMA KS 1	(2013) Enclosed and Miscellaneous Distribution Equipment Switches (600 V Maximum)
NEMA ST 20	(2014) Dry-Type Transformers for General Applications
NEMA TC 2	(2020) Standard for Electrical Polyvinyl Chloride (PVC) Conduit
NEMA TC 3	(2021) Polyvinyl Chloride (PVC) Fittings for Use With Rigid PVC Conduit and Tubing
NEMA Z535.4	(2011; R 2017) Product Safety Signs and Labels

NATIONAL FIRE PROTECTION ASSOCIATION (NFPA)

NFPA 70	(2020; ERTA 20-1 2020; ERTA 20-2 2020; ERTA 20-3 2020; TIA 20-1; TIA 20-2; TIA 20-3; TIA 20-4; TIA 20-5; TIA 20-6; TIA 20-7; TIA 20-8; TIA 20-9; TIA 20-10; TIA 20-11; TIA 20-12; TIA 20-13; TIA 20-14; TIA 20-15; TIA 20-16; ERTA 20-4 2022) National Electrical Code
NFPA 70E	(2021) Standard for Electrical Safety in the Workplace

UNDERWRITERS LABORATORIES (UL)

UL 6	(2007; Reprint Sep 2019) UL Standard for Safety Electrical Rigid Metal Conduit-Steel
UL 44	(2018; Reprint May 2021) UL Standard for Safety Thermoset-Insulated Wires and Cables
UL 50	(2015) UL Standard for Safety Enclosures for Electrical Equipment, Non-Environmental Considerations
UL 83	(2017; Reprint Mar 2020) UL Standard for Safety Thermoplastic-Insulated Wires and Cables
UL 248-4	(2010; Reprint Apr 2019) Low-Voltage Fuses - Part 4: Class CC Fuses
UL 248-8	(2011; Reprint Aug 2020) Low-Voltage Fuses - Part 8: Class J Fuses
UL 248-10	(2011; Reprint Aug 2020) Low-Voltage Fuses - Part 10: Class L Fuses
UL 248-12	(2011; Reprint Aug 2020) Low Voltage Fuses - Part 12: Class R Fuses
UL 248-15	(2018) Low-Voltage Fuses - Part 15: Class T Fuses

UL 360	(2013; Reprint Aug 2021) UL Standard for Safety Liquid-Tight Flexible Metal Conduit
UL 467	(2022) UL Standard for Safety Grounding and Bonding Equipment
UL 486A-486B	(2018; Reprint May 2021) UL Standard for Safety Wire Connectors
UL 486C	(2018; Reprint May 2021) UL Standard for Safety Splicing Wire Connectors
UL 510	(2020) UL Standard for Safety Polyvinyl Chloride, Polyethylene and Rubber Insulating Tape
UL 514B	(2012; Reprint May 2020) Conduit, Tubing and Cable Fittings
UL 651	(2011; Reprint May 2022) UL Standard for Safety Schedule 40, 80, Type EB and A Rigid PVC Conduit and Fittings
UL 854	(2020) Standard for Service-Entrance Cables
UL 870	(2016; Reprint Mar 2019) UL Standard for Safety Wireways, Auxiliary Gutters, and Associated Fittings
UL 1660	(2019) Liquid-Tight Flexible Nonmetallic Conduit
UL 4248-1	(2022) UL Standard for Safety Fuseholders - Part 1: General Requirements
UL 4248-12	(2018) UL Standard for Safety Fuseholders - Part 12: Class R

## 1.2 DEFINITIONS

Unless otherwise specified or indicated, electrical and electronics terms used in these specifications, and on the drawings, are as defined in IEEE 100.

## 1.3 SUBMITTALS

Engineer approval is required for submittals with a "E" designation. Submittals not having a "E" designation are for reference only. Submit the following:

### Shop Drawings

Transformers; E

Wireways; E

### Product Data

Circuit Breakers; E

Disconnect Switches; E

Transformers; E

Meters; E

Test Reports

600-volt Wiring Test; E

Grounding System Test; E

Transformer Tests; GE

Certificates

Fuses; E

Manufacturer's Field Reports

Transformer Factory Tests

Operation and Maintenance Data

Electrical Systems; E

Metering; E

#### 1.4 QUALITY ASSURANCE

##### 1.4.1 Fuses

Submit coordination data as specified in paragraph, FUSES of this section.

##### 1.4.2 Regulatory Requirements

Provide equipment, materials, installation, and workmanship in accordance with NFPA 70 unless more stringent requirements are specified or indicated. NECA NEIS 1 shall be considered the minimum standard for workmanship.

##### 1.4.3 Standard Products

Provide materials and equipment that are products of manufacturers regularly engaged in the production of such products which are of equal material, design and workmanship and:

- a. Have been in satisfactory commercial or industrial use for 2 years prior to bid opening including applications of equipment and materials under similar circumstances and of similar size.
- b. Have been on sale on the commercial market through advertisements, manufacturers' catalogs, or brochures during the 2-year period.
- c. Where two or more items of the same class of equipment are required, provide products of a single manufacturer; however, the component parts of the item need not be the products of the same manufacturer unless stated in this section.

##### 1.4.3.1 Alternative Qualifications

Products having less than a 2-year field service record will be acceptable if a certified record of satisfactory field operation for not less than 6000 hours, exclusive of the manufacturers' factory or laboratory tests, is furnished.

##### 1.4.3.2 Material and Equipment Manufacturing Date

Products manufactured more than 3 years prior to date of delivery to site are not acceptable.

## 1.5 MAINTENANCE

### 1.5.1 Electrical Systems

Submit operation and maintenance manuals for electrical systems that provide basic data relating to the design, operation, and maintenance of the electrical distribution system for the building. Include the following:

- a. Single line diagram of the "as-built" building electrical system.
- b. Schematic diagram of electrical control system (other than HVAC, covered elsewhere).
- c. Manufacturers' operating and maintenance manuals on active electrical equipment.

## 1.6 WARRANTY

Provide equipment items supported by service organizations that are reasonably convenient to the equipment installation in order to render satisfactory service to the equipment on a regular and emergency basis during the warranty period of the contract.

## PART 2 PRODUCTS

### 2.1 MATERIALS AND EQUIPMENT

As a minimum, meet requirements of UL, where UL standards are established for those items, and requirements of NFPA 70 for all materials, equipment, and devices.

### 2.2 CONDUIT AND FITTINGS

Conform to the following:

#### 2.2.1 Rigid Metallic Conduit

##### 2.2.1.1 Rigid, Threaded Zinc-Coated Steel Conduit

ANSI C80.1, UL 6.

#### 2.2.2 Rigid Nonmetallic Conduit

PVC Type EPC-40, and EPC-80 in accordance with NEMA TC 2, UL 651.

#### 2.2.3 Liquid-Tight Flexible Metal Conduit, Steel

UL 360, limited to 6 feet.

#### 2.2.4 Fittings for Metal Conduit and Flexible Metal Conduit

UL 514B. Ferrous fittings: cadmium- or zinc-coated in accordance with UL 514B.

##### 2.2.4.1 Fittings for Rigid Metal Conduit

Threaded-type. Split couplings unacceptable.

##### 2.2.5 Fittings for Rigid Nonmetallic Conduit

NEMA TC 3 for PVC and UL 514B.

#### 2.2.6 Liquid-Tight Flexible Nonmetallic Conduit

UL 1660.

### 2.3 CABINETS, JUNCTION BOXES, AND PULL BOXES

UL 50; volume greater than 100 cubic inches, NEMA Type 1 enclosure; sheet steel, hot-dip, zinc-coated. Where exposed to wet, damp, or corrosive environments, NEMA enclosure as indicated.

### 2.4 WIRES AND CABLES

Provide wires and cables in accordance applicable requirements of NFPA 70 and UL for type of insulation, jacket, and conductor specified or indicated. Do not use wires and cables manufactured more than 12 months prior to date of delivery to site.

#### 2.4.1 Conductors

Provide the following:

- a. Conductor sizes and capacities shown are based on copper, unless indicated otherwise.
- b. Conductors No. 8 AWG and larger diameter: stranded.
- c. Conductors No. 10 AWG and smaller diameter: solid.
- d. Conductors for remote control, alarm, and signal circuits, classes 1, 2, and 3: stranded unless specifically indicated otherwise.
- e. All conductors: copper.

##### 2.4.1.1 Minimum Conductor Sizes

Provide minimum conductor size in accordance with the following:

- a. Branch circuits: No. 12 AWG.

#### 2.4.2 Color Coding

Provide color coding for service, feeder, branch, control, and signaling circuit conductors.

##### 2.4.2.1 Ground and Neutral Conductors

Provide color coding of ground and neutral conductors as follows:

- a. Grounding conductors: Green.
- b. Neutral conductors: White.
- c. Exception, where neutrals of more than one system are installed in same raceway or box, other neutrals color coding: white with a different colored (not green) stripe for each.

##### 2.4.2.2 Ungrounded Conductors

Provide color coding of ungrounded conductors in different voltage systems as follows:

- a. 480/277 volt, three-phase
  - (1) Phase A - brown
  - (2) Phase B - orange
  - (3) Phase C - yellow
- b. 120/240 volt, single phase: Black and red

#### 2.4.3 Insulation

Unless specified or indicated otherwise or required by NFPA 70, provide power and lighting wires rated for 600-volts, Type THWN/THHN conforming to UL 83 or Type XHHW conforming to UL 44, except that grounding wire may be type TW conforming to UL 83. Where equipment or devices require 90-degree Centigrade (C) conductors, provide only conductors with 90-degree C insulation or better.

#### 2.4.4 Bonding Conductors

ASTM B1, solid bare copper wire for sizes No. 8 AWG and smaller diameter; ASTM B8, Class B, stranded bare copper wire for sizes No. 6 AWG and larger diameter.

#### 2.4.5 Service Entrance Cables

Service Entrance (SE) and Underground Service Entrance (USE) Cables, UL 854.

### 2.5 SPLICES AND TERMINATION COMPONENTS

UL 486A-486B for wire connectors and UL 510 for insulating tapes. Connectors for No. 10 AWG and smaller diameter wires: insulated, pressure-type in accordance with UL 486A-486B or UL 486C (twist-on splicing connector). Provide solderless terminal lugs on stranded conductors.

### 2.6 DISCONNECT SWITCHES

#### 2.6.1 Disconnect Switches

NEMA KS 1. Provide heavy duty-type switches where indicated, where switches are rated higher than 240 volts, and for double-throw switches. Utilize Class R fuseholders and fuses for fused switches, unless indicated otherwise. Provide horsepower rated for switches serving as the motor-disconnect means. Provide switches in NEMA enclosure as indicated per NEMA ICS 6.

### 2.7 FUSES

NEMA FU 1. Provide complete set of fuses for each fusible switch. Coordinate time-current characteristics curves of fuses serving motors or connected in series with circuit breakers for proper operation. Submit coordination data for approval. Provide fuses with a voltage rating not less than circuit voltage.

#### 2.7.1 Fuseholders

Provide in accordance with UL 4248-1.

#### 2.7.2 Cartridge Fuses, Current Limiting Type (Class R)

UL 248-12, Class time-delay type. Provide only Class R associated fuseholders in accordance with UL 4248-12.

### 2.7.3 Cartridge Fuses, High-Interrupting Capacity, Current Limiting Type (Classes J, L, and CC)

UL 248-8, UL 248-10, UL 248-4, Class J for zero to 600 amperes, Class L for 601 to 6,000 amperes, and Class CC for zero to 30 amperes.

### 2.7.4 Cartridge Fuses, Current Limiting Type (Class T)

UL 248-15, Class T for zero to 1,200 amperes, 300 volts; and zero to 800 amperes, 600 volts.

## 2.8 TRANSFORMERS

Provide transformers in accordance with the following:

- a. NEMA ST 20, general purpose, dry-type, self-cooled, ventilated.
- b. Provide transformers in NEMA 3R enclosure.
- c. Transformer insulation system:
  - (1) 220 degrees C insulation system for transformers 15 kVA and greater, with temperature rise not exceeding 115 degrees C under full-rated load in maximum ambient of 40 degrees C.
- d. Transformer of 150 degrees C temperature rise is not acceptable.
- e. Transformer of 115 degrees C temperature rise: capable of carrying continuously 115 percent of nameplate kVA without exceeding insulation rating.

## 2.9 GROUNDING AND BONDING EQUIPMENT

### 2.9.1 Ground Rods

UL 467. Ground rods: cone pointed copper-clad steel, with minimum diameter of 3/4 inch and minimum length 10 feet. Sectional type rods may be used for rods 20 feet or longer.

## 2.10 MANUFACTURER'S NAMEPLATE

Provide on each item of equipment a nameplate bearing the manufacturer's name, address, model number, and serial number securely affixed in a conspicuous place; the nameplate of the distributing agent will not be acceptable.

## 2.11 FIELD FABRICATED NAMEPLATES

Provide field fabricated nameplates in accordance with the following:

- a. ASTM D709.
- b. Provide laminated plastic nameplates for each equipment enclosure, relay, switch, and device; as specified or as indicated on the drawings.
- c. Each nameplate inscription: identify the function and, when applicable, the position.
- d. Nameplates: melamine plastic, 0.125 inch thick, white with black center core.
- e. Surface: matte finish. Corners: square. Accurately align lettering and engrave into the core.
- f. Minimum size of nameplates: one by 2.5 inches.

- g. Lettering size and style: a minimum of 0.25 inch high normal block style.

## 2.12 WARNING SIGNS

Provide warning signs for flash protection in accordance with NFPA 70E and NEMA Z535.4 for switchboard service meter sections that are in other than dwelling occupancies and are likely to require examination, adjustment, servicing, or maintenance while energized. Provide field installed signs to warn qualified persons of potential electric arc flash hazards when warning signs are not provided by the manufacturer. Provide marking that is clearly visible to qualified persons before examination, adjustment, servicing, or maintenance of the equipment.

## 2.13 WIREWAYS

UL 870. Material: NEMA 4 enclosure per NEMA ICS 6, 16 gauge for heights and depths up to 6 by 6 inches, and 14 gauge for heights and depths up to 12 by 12 inches. Provide in length required for the application with screw- cover.

## 2.14 FACTORY APPLIED FINISH

Provide factory-applied finish on electrical equipment in accordance with the following:

- a. NEMA 250 corrosion-resistance test and the additional requirements as specified herein.
- b. Exterior surfaces of equipment enclosures: thoroughly cleaned followed by a rust-inhibitive phosphatizing or equivalent treatment prior to painting.
- c. Exterior surfaces: free from holes, seams, dents, weld marks, loose scale or other imperfections.
- e. Exterior surfaces: primed, filled where necessary, and given not less than two coats baked enamel with semigloss finish.
- f. Provide manufacturer's coatings for touch-up work.

## 2.15 SOURCE QUALITY CONTROL

### 2.15.1 Transformer Factory Tests

Submittal: include routine NEMA ST 20 transformer test results on each transformer and also provide the results of NEMA "design" and "prototype" tests that were made on transformers electrically and mechanically equal to those specified.

## PART 3 EXECUTION

### 3.1 INSTALLATION

Electrical installations, including weatherproof and hazardous locations and ducts, plenums and other air-handling spaces: conform to requirements of NFPA 70 and IEEE C2 and to requirements specified herein.

#### 3.1.1 Underground Service

Underground service conductors and associated conduit: continuous from service entrance equipment to outdoor power system connection.

#### 3.1.2 Service Entrance Identification



Service entrance disconnect devices, switches, and enclosures: labeled and identified as such.

### 3.1.2.1 Labels

Wherever work results in service entrance disconnect devices in more than one enclosure, as permitted by NFPA 70, label each enclosure, new and existing, as one of several enclosures containing service entrance disconnect devices. Label, at minimum: indicate number of service disconnect devices housed by enclosure and indicate total number of enclosures that contain service disconnect devices. Provide laminated plastic labels conforming to paragraph FIELD FABRICATED NAMEPLATES. Use lettering of at least 0.25 inch in height, and engrave on black-on-white matte finish. Service entrance disconnect devices in more than one enclosure: provided only as permitted by NFPA 70.

### 3.1.3 Wiring Methods

Provide insulated conductors installed in rigid steel conduit or rigid nonmetallic conduit, except where specifically indicated or specified otherwise or required by NFPA 70 to be installed otherwise. Grounding conductor: separate from electrical system neutral conductor. Provide insulated green equipment grounding conductor for circuit(s) installed in conduit and raceways. Minimum conduit size: 3/4 inch in diameter for lighting and power circuits.

#### 3.1.3.1 Pull Wire

Install pull wires in empty conduits. Pull wire: plastic having minimum 200-pound force tensile strength. Leave minimum 36 inches of slack at each end of pull wire.

### 3.1.4 Conduit Installation

Unless indicated otherwise, conceal conduit under concrete slabs. Install conduit parallel with or at right angles to concrete deck.

#### 3.1.4.1 Restrictions Applicable to Nonmetallic Conduit

##### a. PVC Schedule 40 and PVC Schedule 80

(1) Do not use where subject to physical damage

(2) Do not use above grade, except where allowed in this section for rising through floor slab or indicated otherwise.

-(4) Do not use when the enclosed conductors must be shielded from the effects of High-altitude Electromagnetic Pulse (HEMP).

#### 3.1.4.2 Underground Conduit

PVC, Type EPC-40. Convert nonmetallic conduit to rigid, or steel conduit before rising through concrete slab.

#### 3.1.4.3 Stub-Ups

Provide conduits stubbed up through concrete slab for connection to free-standing equipment with adjustable top or coupling threaded inside for plugs, set flush with finished grade. Extend conductors to equipment in rigid steel conduit. Where no equipment connections are made, install screwdriver-operated threaded flush plugs in conduit end.

#### 3.1.4.4 Conduit Support

Support conduit with existing and proposed trapeze pipe hangers. Plastic cable ties are not acceptable. Fasten by concrete inserts or expansion bolts in concrete slabs. Threaded C-clamps may be used on rigid steel conduit only. Do not weld conduits or pipe straps to steel structures. Do not exceed one-fourth proof test load for load applied

to fasteners. Provide vibration resistant and shock-resistant fasteners attached to concrete slabs. Do not cut main reinforcing bars for any holes cut to depth of more than 1 1/2 inches in reinforced concrete beams or to depth of more than 3/4 inch in concrete joints. Fill unused holes. For conduits greater than 2 1/2 inches inside diameter, provide supports to resist forces of 0.5 times the equipment weight in any direction and 1.5 times the equipment weight in the downward direction.

#### 3.1.4.5 Directional Changes in Conduit Runs

Make changes in direction of runs with symmetrical bends or cast-metal fittings. Make field-made bends and offsets with hickey or conduit-bending machine. Do not install crushed or deformed conduits. Avoid trapped conduits. Prevent plaster, dirt, or trash from lodging in conduits, boxes, fittings, and equipment during construction. Free clogged conduits of obstructions.

#### 3.1.4.6 Locknuts and Bushings

Fasten conduits to sheet metal boxes and cabinets with two locknuts where required by NFPA 70, where insulated bushings are used, and where bushings cannot be brought into firm contact with the box; otherwise, use at least minimum single locknut and bushing. Provide locknuts with sharp edges for digging into wall of metal enclosures. Install bushings on ends of conduits, and provide insulating type where required by NFPA 70.

#### 3.1.4.7 Flexible Connections

Install flexible conduit to allow 20 percent slack. Minimum flexible steel conduit size: 3/4 inch diameter. Provide liquid tight flexible conduit in wet and damp locations for equipment subject to vibration or movement.

#### 3.1.5 Boxes, Outlets, and Supports

Provide boxes in wiring and raceway systems wherever required for pulling of wires, making connections, and mounting of devices or fixtures. Boxes for metallic raceways: cast-metal, hub-type when located in wet locations, when surface mounted on outside of exterior surfaces and when specifically indicated. Provide each box with volume required by NFPA 70 for number of conductors enclosed in box. Fasten boxes and supports with bolts and expansion shields in concrete slabs. Where bar hangers are used, attach bar to raceways on opposite sides of box, and support raceway with approved-type fastener maximum 24 inches from box. When penetrating reinforced concrete members, avoid cutting reinforcing steel.

##### 3.1.5.1 Pull Boxes

Construct of at least minimum size required by NFPA 70 except where cast-metal boxes are required in locations specified herein. Provide boxes with screw-fastened covers. Where several feeders pass through common pull box, tag feeders to indicate clearly electrical characteristics, circuit number, and panel designation.

#### 3.1.6 Mounting Heights

Mount disconnecting switches so height of center of grip of the operating handle of the switch or circuit breaker at its highest position is maximum 79 inches above floor or working platform or as allowed in Section 404.8 per NFPA 70.

#### 3.1.7 Conductor Identification

Provide conductor identification within each enclosure where tap, splice, or termination is made. For conductors No. 6 AWG and smaller diameter, provide color coding by factory-applied, color-impregnated insulation. For conductors No. 4 AWG and larger diameter, provide color coding by plastic-coated, self-sticking markers; colored nylon cable ties and plates; or heat shrink-type sleeves. Identify control circuit terminations in accordance with manufacturer's recommendations.

### 3.1.7.1 Marking Strips

Provide marking strips for identification of power distribution, control, data, and communications cables in accordance with the following:

- a. Provide white or other light-colored plastic marking strips, fastened by screws to each terminal block, for wire designations.
- b. Use permanent ink for the wire numbers
- c. Provide reversible marking strips to permit marking both sides, or provide two marking strips with each block.
- d. Size marking strips to accommodate the two sets of wire numbers.
- e. Assign a device designation in accordance with NEMA ICS 1 to each device to which a connection is made. Mark each device terminal to which a connection is made with a distinct terminal marking corresponding to the wire designation used on the Contractor's schematic and connection diagrams.
- f. The wire (terminal point) designations used on the Contractor's wiring diagrams and printed on terminal block marking strips may be according to the Contractor's standard practice; however, provide additional wire and cable designations for identification of remote (external) circuits for the Owner's wire designations.
- g. Prints of the marking strips drawings submitted for approval will be so marked and returned to the Contractor for addition of the designations to the terminal strips and tracings, along with any rearrangement of points required.

### 3.1.8 Splices

Make splices in accessible locations. Make splices in conductors No. 10 AWG and smaller diameter with insulated, pressure-type connector. Make splices in conductors No. 8 AWG and larger diameter with solderless connector, and cover with insulation material equivalent to conductor insulation.

### 3.1.9 Covers and Device Plates

Install plates with alignment tolerance of 1/16 inch. Use of sectional-type device plates are not permitted. Provide gasket for plates installed in wet locations.

### 3.1.10 Grounding and Bonding

Provide in accordance with NFPA 70. Ground exposed, non-current-carrying metallic parts of electrical equipment, metallic raceway systems, grounding conductor in metallic and nonmetallic raceways, and neutral conductor of wiring systems. Make ground connection at main service equipment. Interconnect all grounding media in or on the structure to provide a common ground potential including the electrical service. Where ground fault protection is employed, ensure that connection of ground and neutral does not interfere with correct operation of fault protection.

#### 3.1.10.1 Ground Rods

Provide cone pointed ground rods. Measure the resistance to ground using the fall-of-potential method described in IEEE 81. Do not exceed 25 ohms under normally dry conditions for the maximum resistance of a driven ground. If this resistance cannot be obtained with a single rod, additional rods, spaced on center, not less than twice the distance of the length of the rod may be used. If the resultant resistance exceeds 25 ohms measured not less than 48 hours after rainfall, notify the Engineer who will decide on the number of ground rods to add.

#### 3.1.10.2 Grounding Connections

Make grounding connections which are buried or otherwise normally inaccessible, by exothermic weld or high compression connector.

- a. Make exothermic welds strictly in accordance with the weld manufacturer's written recommendations. Welds which are "puffed up" or which show convex surfaces indicating improper cleaning are not acceptable. Mechanical connectors are not required at exothermic welds.
- b. Make high compression connections using a hydraulic or electric compression tool to provide the correct circumferential pressure. Provide tools and dies as recommended by the manufacturer. Use an embossing die code or other standard method to provide visible indication that a connector has been adequately compressed on the ground wire.

#### 3.1.10.3 Ground Bus

Noncurrent-carrying metal parts of electrical equipment: effectively grounded by bonding to the ground bus. Bond the ground bus to both the entrance ground, and to a ground rod or rods as specified. Make connections and splices of the brazed, welded, bolted, or pressure-connector type. Use only pressure connectors or bolted connections for connections to removable equipment.

#### 3.1.10.4 Resistance

Maximum resistance-to-ground of grounding system: do not exceed 5 ohms under dry conditions. Where resistance obtained exceeds 5 ohms, contact Engineer for further instructions.

#### 3.1.11 Repair of Existing Work

Perform repair of existing work as follows:

##### 3.1.11.1 Workmanship

Lay out work in advance. Exercise care where cutting, channeling, chasing, or drilling of pier structural members, or other surfaces is necessary for proper installation, support, or anchorage of conduit, raceways, or other electrical work. Repair damage to structural members or electrical equipment using skilled craftsmen of trades involved.

##### 3.1.11.2 Continuation of Service

Maintain continuity of existing circuits of equipment to remain. Maintain existing circuits of equipment energized. Restore circuits wiring and power which are to remain but were disturbed during demolition back to original condition.

#### 3.1.12 Watthour Meters

ANSI C12.1. Install per PG&E service standards.

#### 3.2 FIELD FABRICATED NAMEPLATE MOUNTING

Provide number, location, and letter designation of nameplates as indicated. Fasten nameplates to the device with a minimum of two sheet-metal screws or two rivets.

#### 3.3 WARNING SIGN MOUNTING

Provide the number of signs required to be readable from each accessible side. Space the signs in accordance with NFPA 70E.

### 3.4 FIELD APPLIED PAINTING

Paint electrical equipment as required to match finish of adjacent surfaces or to meet the indicated or specified safety criteria. Where field painting of enclosures for electrical equipment is specified to match adjacent surfaces, to correct damage to the manufacturer's factory applied coatings, or to meet the indicated or specified safety criteria, provide manufacturer's recommended coatings and apply in accordance to manufacturer's instructions.

### 3.5 FIELD QUALITY CONTROL

Furnish test equipment and personnel and submit written copies of test results. Give Engineer and Owner 5 working days notice prior to each test. Where applicable, test electrical equipment in accordance with NETA ATS.

#### 3.5.1 Devices Subject to Manual Operation

Operate each device subject to manual operation at least five times, demonstrating satisfactory operation each time.

#### 3.5.2 600-Volt Wiring Test

Test wiring rated 600 volt and less to verify that no short circuits or accidental grounds exist. Perform insulation resistance tests on wiring No. 6 AWG and larger diameter using instrument which applies voltage of 1,000 volts DC for 600 volt rated wiring and 500 volts DC for 300 volt rated wiring per NETA ATS to provide direct reading of resistance. All existing wiring to be reused must also be tested.

#### 3.5.3 Transformer Tests

Perform the standard, not optional, tests in accordance with the Inspection and Test Procedures for transformers, dry type, air-cooled, 600 volt and below; as specified in NETA ATS. Measure primary and secondary voltages for proper tap settings. Tests need not be performed by a recognized independent testing firm or independent electrical consulting firm.

#### 3.5.4 Grounding System Test

Test grounding system to ensure continuity, and that resistance to ground is not excessive. Test each ground rod for resistance to ground before making connections to rod; tie grounding system together and test for resistance to ground. Make resistance measurements in dry weather, not earlier than 48 hours after rainfall. Submit written results of each test to Engineer, and indicate location of rods as well as resistance and soil conditions at time measurements were made.

#### 3.5.5 Watthour Meter

##### a. Visual and mechanical inspection

- (1) Examine for broken parts, shipping damage, and tightness of connections.
- (2) Verify that meter type, scales, and connections are in accordance with approved shop drawings.

##### b. Electrical tests

- (1) Determine accuracy of meter.
- (2) Calibrate watthour meters to one-half percent.
- (3) Verify that correct multiplier has been placed on face of meter, where applicable.

-- End of Section --

# **BID FORM**

**BID FORM**

**TO: SAN MATEO COUNTY HARBOR DISTRICT  
EL GRANADA, CA**

Pursuant to the Notice Inviting Bids, the undersigned bidder herewith submits a bid on the bidding form or forms attached hereto and made a part hereof and binds itself on award by the San Mateo County Harbor District under this bid to execute a contract in accordance with its bid, the bid documents and the award. The attached Notice Inviting Bids, General Conditions and Instructions for Bidders, Special Provisions, Technical Specifications, Bid Forms, and Addenda, if any, are made a part of this bid and all provisions thereof are accepted, and all representations and warranties required thereby are hereby affirmed.

Bids below include all applicable charges, including labor, insurance, bonding, and other costs necessary for the furnishing of all equipment and the performance of all services called for under the Contract. Prices quoted shall include all sales or use taxes.

**BIDDER SHALL SUBMIT QUOTES FOR ALL ITEMS**

**CONTRACT NO. 2024-03**

**Johnson Pier Electric  
Upgrades**

.....  
The Bid Form must be signed below in accordance with the General Conditions and Special Provisions. Bids submitted in any other form will be considered non-responsive and may be rejected.



## Johnson Pier Electric Upgrades

ITEM #	DESCRIPTION	QTY	UNITS	UNIT COST	SUB TOTAL
1	Mobilization, Demobilization, Bonds, Insurance	1	LS		
2	Johnson Pier Distribution Panel feeder/service reconfiguration.	1	LS		
3	Fuel Dock Distribution Panel feeder/service reconfiguration.	1	LS		
4	Fish Buyer service feeder.	1	LS		
5	Fish buyer 480V panelboard.	1	LS		
6	Revenue Grade Submeters.	3	EA		
7	50KVA Transformers.	3	EA		
8	Fish Buyer Service Disconnects and associated conduit/wire.	3	EA		
	<b>TOTAL BID PRICE</b>				

-----

Name Under Which Business is Conducted: \_\_\_\_\_

Business Address: \_\_\_\_\_

Telephone Number: \_\_\_\_\_ Facsimile Number: \_\_\_\_\_

E-Mail Address: \_\_\_\_\_

**MANDATORY SIGNATURE(S)**  
**(See General Condition 3 and Special Provision 1.3)**

**IF SOLE OWNER, sign here:** I sign as sole owner of the business named above.

Entity Name: \_\_\_\_\_

By: \_\_\_\_\_ Title: \_\_\_\_\_

Signature: \_\_\_\_\_

**IF PARTNERSHIP, one or more partners sign here:** The undersigned certify that we are partners in the business named above and that we sign this Contract proposal with full authority to do so.

Entity Name: \_\_\_\_\_

By: \_\_\_\_\_ Title: \_\_\_\_\_

Signature: \_\_\_\_\_

**IF CORPORATION OR LCC, sign here:** The undersigned certify that they sign this Contract proposal with full and proper authorization to do so.

Entity Name: \_\_\_\_\_

By: \_\_\_\_\_ Title: \_\_\_\_\_

Signature: \_\_\_\_\_

\*By: \_\_\_\_\_ Title: \_\_\_\_\_

Signature: \_\_\_\_\_

Incorporated under the laws of the State of \_\_\_\_\_

\* If the Bidder is a corporation, this Bid Form must be executed by two corporate officers, consisting of: (1) the president, vice president or chair of the board; and (2) the secretary, assistant secretary, chief financial officer or assistant treasurer. In the alternative, this Bid Form may be executed by a single officer or a person other than an officer provided that evidence satisfactory to the District is provided, demonstrating that such individual is authorized to bind the corporation (e.g. a copy of a certified resolution from the corporation's board or a copy of the corporation's bylaws).

**IF JOINT VENTURE, officers of each participating firm sign here:** The undersigned certify that they sign this Contract proposal with full and proper authorization to do so:

Joint Venture Name composed of: \_\_\_\_\_

By \_\_\_\_\_ Title \_\_\_\_\_

Signature: \_\_\_\_\_

**DOCUMENTS TO ACCOMPANY BID:**

\_\_\_\_\_ The Bidder's Bond or certified or cashier's check required by Section 14 of the General Conditions and Special Provision 1.10, in an amount equal to at least ten percent (10%) of the Total Bid Price

\_\_\_\_\_ List of Subcontractors

\_\_\_\_\_ Acknowledgment of Addenda, if any

\_\_\_\_\_ Qualification Questionnaire

\_\_\_\_\_ Proof of DIR Registration in accordance with Special Provision 5.14

\_\_\_\_\_ Non-Collusion Declaration

**BIDDER'S BOND**

KNOW ALL PERSONS BY THESE PRESENTS:

That \_\_\_\_\_, as Principal, and \_\_\_\_\_, as Surety, are held and firmly bound unto the SAN MATEO COUNTY HARBOR DISTRICT, hereinafter called the District, in the sum of \_\_\_\_\_ (\$ \_\_\_\_\_) being at least ten percent (10%) of the total amount of the bid of the Principal above named for **CONTRACT NO. 2024-03, Johnson Pier Electric Upgrades**, for the payment of which sum in lawful money of the United States, well and truly to made to the District, we bind ourselves, our heirs, executors, administrators, successors, and assigns, jointly and severally, firmly by these presents.

The condition of the above obligation is such that, whereas the Principal has submitted said bid to the District;

**NOW THEREFORE**, if the Principal is awarded a contract by the District and, within the time and in the manner required by the Specifications, enters into a written contract with the District and furnishes the requisite bond or bonds, then this obligation shall become null and void, otherwise to remain in full force and effect.

In the event suit is brought upon this bond by the District and Judgment is recovered, the Surety shall pay all costs incurred by the District in such suit, including a reasonable attorney's fee to be fixed by the Court.

Dated \_\_\_\_\_ 2024.

(SEAL)

Principal:

By: \_\_\_\_\_

By: \_\_\_\_\_

(SEAL AND NOTARIAL  
ACKNOWLEDGEMENT OF  
SURETY)

Surety:

By: \_\_\_\_\_

By: \_\_\_\_\_

Note: Signatures of those executing for surety must be properly notarized.

---

**SAMPLE CERTIFICATE OF INSURANCE**

CERTIFICATE OF INSURANCE					CERTIFICATE NUMBER								
PRODUCER  <div style="text-align: center; font-weight: bold; font-size: 1.2em;">- SAMPLE -</div>		THIS CERTIFICATE IS ISSUED AS A MATTER OF INFORMATION ONLY AND CONFERS NO RIGHTS UPON THE CERTIFICATE HOLDER OTHER THAN THOSE PROVIDED IN THE POLICY. THIS CERTIFICATE DOES NOT AMEND, EXTEND OR ALTER THE COVERAGE AFFORDED BY THE POLICIES DESCRIBED HEREIN.											
INSURED  NAMED INSURED AND ADDRESS		COMPANIES AFFORDING COVERAGE											
		COMPANY A											
		COMPANY B											
		COMPANY C											
		COMPANY D											
<b>COVERAGES</b> This certificate supersedes and replaces any previously issued certificate for the policy period noted below.													
THIS IS TO CERTIFY THAT POLICIES OF INSURANCE DESCRIBED HEREIN HAVE BEEN ISSUED TO THE INSURED NAMED HEREIN FOR THE POLICY PERIOD INDICATED. NOTWITHSTANDING ANY REQUIREMENT, TERM OR CONDITION OF ANY CONTRACT OR OTHER DOCUMENT WITH RESPECT TO WHICH THE CERTIFICATE MAY BE ISSUED OR MAY PERTAIN, THE INSURANCE AFFORDED BY THE POLICIES DESCRIBED HEREIN IS SUBJECT TO ALL THE TERMS, CONDITIONS AND EXCLUSIONS OF SUCH POLICIES. AGGREGATE LIMITS SHOWN MAY HAVE BEEN REDUCED BY PAID CLAIMS.													
CO LTR	TYPE OF INSURANCE	POLICY NUMBER	POLICY EFFECTIVE DATE (MM/DD/YY)	POLICY EXPIRATION DATE (MM/DD/YY)	LIMITS								
	<b>GENERAL LIABILITY</b> <input type="checkbox"/> COMMERCIAL GENERAL LIABILITY <input type="checkbox"/> CLAIMS MADE <input type="checkbox"/> OCCUR <input type="checkbox"/> OWNER'S & CONTRACTOR'S PROT				GENERAL AGGREGATE \$ PRODUCTS - COM/OP AGG \$ PERSONAL & ADV INJURY \$ EACH OCCURRENCE \$ FIRE DAMAGE (Any one fire) \$ MED EXP (Any one person) \$								
	<b>AUTOMOBILE LIABILITY</b> <input type="checkbox"/> ANY AUTO <input type="checkbox"/> ALL OWNED AUTOS <input type="checkbox"/> SCHEDULED AUTOS <input type="checkbox"/> HIRED AUTOS <input type="checkbox"/> NON-OWNED AUTOS				COMBINED SINGLE LIMIT \$ BODILY INJURY (Per person) \$ BODILY INJURY (Per accident) \$ PROPERTY DAMAGE \$								
	<b>GARAGE LIABILITY</b> <input type="checkbox"/> ANY AUTO				AUTO ONLY - EA ACCIDENT \$ OTHER THAN AUTO ONLY: EACH ACCIDENT \$ AGGREGATE \$								
	<b>EXCESS LIABILITY</b> <input type="checkbox"/> UMBRELLA FORM <input type="checkbox"/> OTHER THAN UMBRELLA FORM				EACH OCCURRENCE \$ AGGREGATE \$								
	<b>WORKERS COMPENSATION AND EMPLOYERS' LIABILITY</b>  THE PROPRIETOR/PARTNERS/EXECUTIVE OFFICERS ARE: <input type="checkbox"/> INCL <input type="checkbox"/> EXCL				<table border="1" style="width: 100%; border-collapse: collapse; font-size: 0.8em;"> <tr> <td style="width: 60%;">WC STATUTORY LIMITS</td> <td style="width: 40%;">OTHER</td> </tr> <tr> <td colspan="2">EL EACH ACCIDENT \$</td> </tr> <tr> <td colspan="2">EL DISEASE-POLICY LIMIT \$</td> </tr> <tr> <td colspan="2">EL DISEASE-EACH EMPLOYEE \$</td> </tr> </table>	WC STATUTORY LIMITS	OTHER	EL EACH ACCIDENT \$		EL DISEASE-POLICY LIMIT \$		EL DISEASE-EACH EMPLOYEE \$	
WC STATUTORY LIMITS	OTHER												
EL EACH ACCIDENT \$													
EL DISEASE-POLICY LIMIT \$													
EL DISEASE-EACH EMPLOYEE \$													
	<b>OTHER</b> <input type="checkbox"/> PROFESSIONAL LIABILITY				EACH OCCURRENCE \$ AGGREGATE \$								
DESCRIPTION OF OPERATIONS/LOCATIONS/VEHICLES/SPECIAL ITEMS													
<b>CERTIFICATE HOLDER</b>			<b>CANCELLATION</b> SHOULD ANY OF THE POLICIES DESCRIBED HEREIN BE CANCELLED BEFORE THE EXPIRATION DATE THEREOF, THE INSURER AFFORDING COVERAGE WILL ENDEAVOR TO MAIL <u>30</u> DAYS WRITTEN NOTICE TO THE CERTIFICATE HOLDER NAMED HEREIN, BUT FAILURE TO MAIL SUCH NOTICE SHALL IMPOSE NO OBLIGATION OR LIABILITY OF ANY KIND UPON THE INSURER AFFORDING COVERAGE, ITS AGENTS OR REPRESENTATIVES, OR THE ISSUER OF THIS CERTIFICATE.										
			BY: CATEGORY ____										
					<b>VALID AS OF:</b> _____								

**LIST OF SUBCONTRACTORS**

The Bidder is required to furnish the following information in accordance with the provisions of Sections 4100 to 4114, inclusive, of the Public Contract Code of the State of California. This list and information shall include all subcontractors that will perform work, provide labor or render services to the Bidder in connection with the project in an amount in excess of one-half of one percent of the total amount of Bidder's proposal.

Do not list alternative subcontractors for the same work. Use additional sheets if necessary.

NAME OF SUBCONTRACTOR	LICENSE NUMBER	LOCATION OF/ PLACE OF BUSINESS	PORTION OF WORK
1.			
2.			
3.			
4.			
5.			
6.			
7.			
8.			
9.			
10.			
11.			
12.			
13.			
14.			
15.			
16.			

**ACKNOWLEDGMENT OF ADDENDA**  
**Johnson Pier Electric Upgrades**

The undersigned Bidder acknowledges receipt of the following addenda, if issued, to the Bid Documents. If none received, write "None Received".

Addendum No. \_\_\_\_\_, dated \_\_\_\_\_

Addendum No. \_\_\_\_\_, dated \_\_\_\_\_

Addendum No. \_\_\_\_\_, dated \_\_\_\_\_

Date: \_\_\_\_\_

Firm: \_\_\_\_\_

Signature: \_\_\_\_\_

Print Name: \_\_\_\_\_

Title: \_\_\_\_\_



**QUALIFICATION QUESTIONNAIRE AND  
FINANCIAL STATEMENT WITH BUSINESS REFERENCES**

\_\_\_\_\_  
Name of Applicant or Firm ( ) Telephone

\_\_\_\_\_  
( ) Facsimile

\_\_\_\_\_  
Street Address (NOTE: If using a P.O. Box, please list both P.O. Box No. AND Street Address)

\_\_\_\_\_  
City, State, Zip

Date Submitted:  
\_\_\_\_\_

Fiscal Year Ending:  
\_\_\_\_\_

\_\_\_\_\_  
The above applicant or firm is:

A parent firm of: \_\_\_\_\_  
\_\_\_\_\_

A subsidiary division of: \_\_\_\_\_  
\_\_\_\_\_

1. How many years has your organization been in business as a contractor under your present name?

\_\_\_\_\_

2. How many years' experience:

a) As a prime contractor: \_\_\_\_\_

b) As a subcontractor: \_\_\_\_\_

3. Are you registered as a contractor or subcontractor with the California Department of Industrial Relations? \_\_\_\_\_

Registration No.: \_\_\_\_\_ Registration expiration date: \_\_\_\_\_

**\*\*BIDDER MUST SUBMIT PROOF OF CONTRACTOR REGISTRATION WITH THE DIR IN THE FORM OF A HARD COPY OF THE RELEVANT PAGE OF THE DIR'S DATABASE FOUND AT: <https://efiling.dir.ca.gov/PWCR/Search>\*\***

4. List below at least three contracts your organization has performed in the last five years involving the demolition of structures in a marine environment.

CONTRACT \$ AMOUNT	PERCENT COMPLETED	CONTRACTING AGENCY AND ADDRESS, NAME AND PHONE OF OWNER/AGENCY REPRESENTATIVE

(Use separate sheet if more listing space is needed.)

5. Have you ever failed to complete any work awarded to you, or have you ever been disqualified, removed, or otherwise prevented from bidding on or completing any federal, state or local government project because of a violation of law or safety regulation?

( ) Yes ( ) No

If so, where and why? \_\_\_\_\_

\_\_\_\_\_

\_\_\_\_\_

---

---

6. The Contractor shall dispose of any hazardous wastes under its own EPA generator number. Please provide your EPA Generator Number:

---

7. What is the construction experience of the principal officers and key employees (including superintendents) of your organization?

<b>INDIVIDUAL'S NAME</b>	<b>PRESENT POSITION OR OFFICE</b>	<b>YEARS OF CONSTRUCTION EXPERIENCE</b>	<b>MAGNITUDE &amp; TYPE OF WORK</b>	<b>IN WHAT CAPACITY</b>

8. List facilities that are available for anticipated work. (In Column 3, indicate ownership status of equipment and facilities if available: O-Own, L-Lease.)

QTY.	ITEM (DESCRIPTION, SIZE, CAPACITY, ETC.)	OWNERSHIP	CONDITION	YEARS OF SERVICE	PRESENT LOCATION

9. Give information below about all your contract work underway or to which you are committed.

TYPE OF WORK	LOCATION	VALUE	PERCENT COMPLETE	SCHEDULED COMPLETION DATE	FOR WHOM PERFORMED

10. References: Give only engineers, architects, or owners, including public bodies, for whom you have done work.

NAME	ADDRESS	BUSINESS

**REFERENCES**

1. Please list 3 bank references familiar with the Bidder's accounts:

- a) Name of Bank: \_\_\_\_\_  
Street Address: \_\_\_\_\_  
City and State: \_\_\_\_\_ Telephone: \_\_\_\_\_  
Officer Familiar with Bidder's Account: \_\_\_\_\_
  
- b) Name of Bank: \_\_\_\_\_  
Street Address: \_\_\_\_\_  
City and State: \_\_\_\_\_ Telephone: \_\_\_\_\_  
Officer Familiar with Bidder's Account: \_\_\_\_\_
  
- c) Name of Bank: \_\_\_\_\_  
Street Address: \_\_\_\_\_  
City and State: \_\_\_\_\_ Telephone: \_\_\_\_\_  
Officer Familiar with Bidder's Account: \_\_\_\_\_

**NON-COLLUSION DECLARATION TO BE EXECUTED BY BIDDER  
AND SUBMITTED WITH BID**

The undersigned declares:

I am the \_\_\_\_\_ of \_\_\_\_\_, the party making the foregoing bid.

The bid is not made in the interest of, or on behalf of, any undisclosed person, partnership, company, association, organization, or corporation. The bid is genuine and not collusive or sham. The bidder has not directly or indirectly induced or solicited any other bidder to put in a false or sham bid. The bidder has not directly or indirectly colluded, conspired, connived, or agreed with any bidder or anyone else to put in a sham bid, or to refrain from bidding. The bidder has not in any manner, directly or indirectly, sought by agreement, communication, or conference with anyone to fix the bid price of the bidder or any other bidder, or to fix any overhead, profit, or cost element of the bid price, or of that of any other bidder. All statements contained in the bid are true. The bidder has not, directly or indirectly, submitted his or her bid price or any breakdown thereof, or the contents thereof, or divulged information or data relative thereto, to any corporation, partnership, company association, organization, bid depository, or to any member or agent thereof to effectuate a collusive or sham bid, and has not paid, and will not pay, any person or entity for such purpose.

Any person executing this declaration on behalf of a bidder that is a corporation, partnership, joint venture, limited liability company, limited liability partnership, or any other entity, hereby represents that he or she has full power to execute, and does execute, this declaration on behalf of the bidder.

I declare under penalty of perjury under the laws of the State of California that the foregoing is true and correct and that this declaration is executed on \_\_\_\_\_ [date], at \_\_\_\_\_ [city], \_\_\_\_\_ [state].

\_\_\_\_\_  
Signature of Bidder

\_\_\_\_\_  
Title

\_\_\_\_\_  
Date

**SAMPLE CONTRACT**

THIS CONTRACT is made and entered into this \_\_\_\_\_ day of \_\_\_\_\_, by and between SAN MATEO COUNTY HARBOR DISTRICT (referred to as "District") and \_\_\_\_\_ (referred to as "Contractor").

The Contractor and the District, for the consideration hereinafter named, agree as follows:

**Scope of Work.** The Contractor shall furnish the District all the labor, materials and equipment required to complete the work more particularly described in the specifications approved by the District entitled:

**CONTRACT NO. \_\_\_\_\_**  
***[INSERT CONTRACT TITLE]***

and which are appended hereto and made part of the Contract.

The Contractor shall perform the following work listed on the Bid Form.

\_\_\_\_\_

The District has the right to inspect the ongoing installation process on a daily basis, if necessary, and there will be a final inspection by a District representative.

**Time of Performance.** The Contractor shall begin work upon issuance of the Notice to Proceed, and shall diligently prosecute all of the work under this Contract in all parts and requirements to completion by **[INSERT TIME OF PERFORMANCE]**, as provided in the Specifications.

**Contract Price.** The Contractor shall faithfully perform each and every item required of it in this Contract for the sum of \_\_\_\_\_

\_\_\_\_\_  
\_\_\_\_\_  
\_\_\_\_\_  
\_\_\_\_\_  
\_\_\_\_\_  
\_\_\_\_\_  
\_\_\_\_\_

Dollars (\$ \_\_\_\_\_

\_\_\_\_\_) ,

which includes all applicable charges, including taxes, freight and delivery charges, insurance and all other costs necessary for the furnishing of all material and the performance of all the services called for under the Contract. Payments to Contractor shall be made at the time and in the manner provided in the Contract.

**Term of Contract.** The term of this Contract shall commence upon District's issuance of a Notice to Proceed. Following District's final acceptance of the replacement of a **[INSERT WORK TO BE**



**PERFORMED]**, all work, including all installation work or repairs, is guaranteed by the Contractor against failure, damage, defect, or non-compliance with the Contract of any kind for a period of one (1) year from the date of District's final acceptance. **[UPDATE WARRANTY REQUIREMENT AS DESIRED]**

**Component Parts.** This Contract shall consist of the following documents, each of which is on file in the Office of the Secretary and all of which are incorporated herein and made a part hereof by reference thereto:

- A. Contract
- B. Bid Documents: Notice Inviting Bids, General Conditions and Instructions for Bidders, Special Provisions and Technical Specifications
- C. Bid Form (As Accepted by the District)
- E. Addenda No. \_\_\_\_\_ to \_\_\_\_\_
- F. Performance Bond
- G. Payment Bond
- H. Insurance Certificates

**Service Notice.** Any notice required or permitted to be given by this Contract shall be deemed given when personally delivered to recipient thereof or mailed by registered or certified mail, return receipt requested, postage prepaid, to the appropriate recipient thereof, in the case of the Contractor, at the business address specified in its proposal, and in the case of the District, at PO Box 1449, El Granada, CA, 94018, or at any other address which either party may subsequently designate in writing to the other party.

**Publicity.** The Contractor, its employees, subcontractors, and agents shall not refer to the District, or use any logos, images, or photographs of the District for any commercial purpose, including, but not limited to, advertising, promotion, or public relations, without the District's prior written consent. Such written consent shall not be required for the inclusion of the District's name on a customer list.

**Governing Law.** This Contract shall be governed and construed in accordance with the laws of the State of California. Any action relating to, and all disputes arising under, this Contract shall be instituted and prosecuted in a court of competent jurisdiction in the State of California. Each party hereby appoints the individual listed opposite its name to act as its initial agent for service of process relating to any such action.

**SAMPLE CONTRACT**

IN WITNESS WHEREOF, the District has caused these presents to be executed by the District's officer thereunto duly authorized, and the Contractor has subscribed same, all on the day and year first above written.

**FOR THE CONTRACTOR:**

Name Under Which Business is Conducted: \_\_\_\_\_

Business Address: \_\_\_\_\_

City/State/Zip: \_\_\_\_\_

Telephone No. \_\_\_\_\_ Facsimile No. \_\_\_\_\_

**If SOLE OWNER, sign here:**

I sign as sole owner of the business named above.

\_\_\_\_\_

**If PARTNERSHIP, sign here:**

The undersigned certify that they are partners in the business named above and that they sign this contract bid proposal with full authority to do so (One or more partners sign).

\_\_\_\_\_

\_\_\_\_\_

**If CORPORATION OR LLC, execute here:**

The undersigned certify that they sign this contract bid proposal with full and proper authorization to do so.

Entity name: \_\_\_\_\_

By: \_\_\_\_\_ Title: \_\_\_\_\_

\* By: \_\_\_\_\_ Title: \_\_\_\_\_

Incorporated under the laws of the State of: \_\_\_\_\_

*\* If the Contractor is a corporation, this Contract must be executed by two corporate officers, consisting of: (1) the president, vice president or chair of the board; and (2) the secretary, assistant secretary, chief financial officer or assistant treasurer. In the alternative, this Contract may be executed by a single officer or a person other than an officer provided that evidence satisfactory to the District is provided demonstrating that such individual is authorized to bind the corporation (e.g. a copy of a certified resolution from the corporation's board or a copy of the corporation's bylaws.)*

**If JOINT VENTURE, Sign Here:**

The undersigned certify that they sign this contract bid proposal with full and proper authorization to do so.

Joint Venture Name Composed of: \_\_\_\_\_

By: \_\_\_\_\_ Title: \_\_\_\_\_

By: \_\_\_\_\_ Title: \_\_\_\_\_

Incorporated under the laws of the State of: \_\_\_\_\_

**FOR THE SAN MATEO COUNTY HARBOR DISTRICT:**

\_\_\_\_\_

General Manager

## **San Mateo County Harbor District**

504 Avenue Alhambra, 2<sup>nd</sup> Floor, PO Box 1449  
El Granada, CA 94018

### ***For Immediate Release***

**DATE: April 19, 2024**

**Contact: Capital Improvement Project San  
Mateo County Harbor District  
(650) 583-4962**

El Granada, CA—

### **PUBLIC NOTICE**

#### **INVITATION TO BID**

NOTICE IS HEREBY GIVEN that the San Mateo County Harbor District will receive sealed bids for the **Johnson Pier Electric Upgrades..** Prospective Bidders are directed to the San Mateo County Harbor District's website for construction documents and further information.

**Sealed** Bid Proposals shall be submitted to the San Mateo County Harbor District, Administration Office, **no later than 2:00 p.m. local time on Jun 5, 2024**, at 504 Avenue Alhambra, 2<sup>nd</sup> Floor, El Granada, CA 94018.

PROJECT BID SPECIFICATIONS ARE IMMEDIATELY AVAILABLE at the San Mateo County Harbor District, 504 Avenue Alhambra, 2<sup>nd</sup> Floor, El Granada, CA 94018 or on the District's website at [www.smharbor.com](http://www.smharbor.com). Phone 650-583-4962.

A MANDATORY pre-bid conference will be held on **April 29 at 2:00 p.m.** at the Pillar Point Harbor **Office of the Harbor Master**. The job walk is MANDATORY.

Bid and Material & Labor Bonds are required as part of this agreement.

The District reserves the right to reject any and all bids and to waive any irregularities therein. The award of this contract shall be made to the lowest responsible and responsive bidder. No proposals will be accepted by facsimile or electronic mail.

**PERFORMANCE BOND**

KNOW ALL PERSONS BY THESE PRESENTS, that

WHEREAS THE SAN MATEO COUNTY HARBOR DISTRICT, (hereinafter referred to as "District") has entered into a Contract with (Contractor Name) (hereinafter referred to as "Principal") for the **CONTRACT NO. 2024-03, Johnson Pier Electric Upgrades** ("Contract"); and

WHEREAS, said Principal is required under the terms of said Contract to furnish a bond of faithful performance of said Contract;

NOW, THEREFORE, we, the Principal, and \_\_\_\_\_, as Surety are held and firmly bound unto the District, in the penal sum of \_\_\_\_\_ Dollars (\$ \_\_\_\_\_) lawful money of the United States, being a sum equal to one hundred percent (100%) of the total amount payable under the Contract, for the payment of which sum, well and truly to be made, we bind ourselves, our heirs, executors, administrators, and successors, jointly and severally, firmly by these presents.

THE CONDITION OF THIS OBLIGATION IS SUCH, that if the above-bound Principal, or its heirs, executors, administrators, successors, or assigns approved by the District, shall promptly and faithfully perform the covenants, conditions and agreements in the Contract during the original term and any extensions thereof as may be granted by the District, with or without notice to Surety, and during the period of any guarantees or warranties required under the Contract, and shall also promptly and faithfully perform all the covenants, conditions, and agreements of any alteration of the Contract made as therein provided, notice of which alterations to Surety being hereby waived, on Principal's part to be kept and performed at the time and in the manner therein specified, and in all respects according to their true intent and meaning, and shall indemnify, defend, protect, and hold harmless the District as stipulated in the Contract, then this obligation shall be removed; otherwise it shall be and remain in full force and effect.

No extension of time, change, alteration, modification, or addition to the Contract, or of the work required thereunder, shall release or exonerate Surety on this bond or in any way affect the obligation of this bond; and Surety does hereby waive notice of any such extension of time, change, alteration, modification, or addition.

Whenever Principal shall be and declared by the District to be in default under the Contract, Surety shall promptly remedy the default, or shall promptly do one of the following at District's election:

1. Undertake through its agents or independent Contractors, reasonably acceptable to the District, to complete the Contract in accordance with its terms and conditions and to pay and perform all obligations of Principal under the Contract, including without limitation, all obligations with respect to warranties, guarantees, and the payment of liquidated damages.

2. Reimburse the District for all costs the District incurs in completing the Contract, including consequential damages and costs associated with resoliciting the Contract, if applicable, negotiation, and completion of the project, and in correcting, repairing or replacing any defects in materials or workmanship and/or materials and workmanship which do not conform to the specifications in the Contract.

Surety's obligations hereunder are independent of the obligations of any other surety for the performance of the Contract, and suit may be brought against Surety and such other sureties, jointly and severally, or against any one or more of them, or against less than all of them without impairing the District's rights against the others.

No right of action shall accrue on this bond to or for the use of any person or corporation other than the District or its successors or assigns.

In the event suit is brought upon this bond by the District, Surety shall pay reasonable attorney's fees and costs incurred by the District in such suit.

IN WITNESS WHEREOF, the above bounded parties have executed this instrument under their seals this \_\_\_\_ day of \_\_\_\_\_, 2021, the name and corporate seal of each corporate party being hereto affixed and these presents duly signed by its undersigned representative, pursuant to authority of its governing body.

\_\_\_\_\_  
(Principal)

NOTE:  
To be signed by Principal  
and Surety and acknowledgement  
and notarial seal attached.

By: \_\_\_\_\_

By: \_\_\_\_\_

\_\_\_\_\_  
(Surety)

\_\_\_\_\_  
(Address)

By: \_\_\_\_\_

By: \_\_\_\_\_

STATE OF CALIFORNIA )  
 ) ss.  
CITY AND COUNTY OF \_\_\_\_\_ )

On \_\_\_\_\_, 2021 before me, \_\_\_\_\_, Notary Public, personally appeared \_\_\_\_\_, personally known to me (or proved to me on the basis of satisfactory evidence) to be the person(s) whose name(s) is/are subscribed to the within instrument and acknowledged to me that he/she/they executed the same in his/her/their authorized capacity(ies), and that by his/her/their signature(s) on the instrument the person(s), or the entity upon behalf of which the person(s) acted, executed the instrument.

I certify under PENALTY OF PERJURY under the laws of the State of California that the foregoing paragraph is true and correct.

Witness my hand and official seal.

Signature \_\_\_\_\_  
Notary Public

TO BE CONSIDERED COMPLETE, BOTH THE BIDDER AND AN ADMITTED SURETY INSURER AUTHORIZED BY THE CALIFORNIA INSURANCE COMMISSIONER TO TRANSACT SURETY BUSINESS IN THE STATE OF CALIFORNIA MUST SIGN THIS PERFORMANCE BOND. IN ADDITION, BOTH THE PRINCIPAL'S AND THE SURETY'S SIGNATURES MUST BE NOTARIZED AND A COPY OF THE SURETY'S POWER OF ATTORNEY MUST BE ATTACHED.

## PAYMENT BOND

KNOW ALL PERSONS BY THESE PRESENTS, that \_\_\_\_\_ called the PRINCIPAL, and \_\_\_\_\_ a corporation duly organized under the laws of the State of \_\_\_\_\_, having its principal place of business at \_\_\_\_\_ in the State of \_\_\_\_\_, and authorized to do business in the State of California, hereinafter called the SURETY, are held and firmly bound unto the San Mateo County Harbor District (District), hereinafter called the OBLIGEE, or order in the sum of \_\_\_\_\_ (\$ \_\_\_\_\_ .00) lawful money of the United States, for the payment of which, well and truly to be made, we bind ourselves, our heirs, executors, administrators and successors, jointly and severally, firmly by these presents.

THE CONDITION OF THIS OBLIGATION IS SUCH THAT:

WHEREAS, the PRINCIPAL has entered into a Contract with the OBLIGEE for **CONTRACT NO. 2024-03, Johnson Pier Electric Upgrades** and said PRINCIPAL is required under the terms of said Contract to furnish a bond securing payment of claims to which reference is made in Section 9554 of the Civil Code.

NOW, THEREFORE, if said PRINCIPAL or any of its subcontractors fails to pay any of the persons named in Section 9100 of the Civil Code, or amounts due under the Unemployment Insurance Code with respect to work or labor performed under the Contract, or any amounts required to be deducted, withheld and paid over to the Employment Development Department from the wages of employees of the Contractor and his subcontractors pursuant to Section 13020 of the Unemployment Insurance Code with respect to such work and labor, the SURETY, will pay for the same, in an amount not exceeding the sum specified in this bond, and also will pay, in case suit is brought upon this bond, a reasonable attorney's fee, to be fixed by the court.

This bond will inure to the benefit of any of the persons named in Section 9100 of the Civil Code so as to give a right of action to such persons or their assigns in any suit brought upon this bond.

This bond is given to comply with Sections 9550 and 9554 of the Civil Code. The liability of the PRINCIPAL and SURETY hereunder is governed by the provisions of said Code, all acts amendatory thereof, and all other statutes referred to therein.

SURETY, for value received, hereby agrees that no change, extension of time, alteration or addition to the terms of the Contract or to the work to be performed thereunder or to the Contract Documents accompanying the same shall in any way affect its obligations on this bond, and it does hereby waive notice of any such change, extension of time, alteration or addition to the terms of the Contract or to the work or to the other portions of the Contract Documents.



IN WITNESS WHEREOF the above-bounded parties have executed this instrument this \_\_\_\_\_ day of \_\_\_\_\_, 2021, the name and corporate seal of each corporate party being hereto affixed and these presents duly signed by its undersigned representatives, pursuant to authority of its governing body.

\_\_\_\_\_  
(Principal)

NOTE:  
To be signed by Principal  
and Surety and acknowledgement  
and notarial seal attached.

By: \_\_\_\_\_

By: \_\_\_\_\_

\_\_\_\_\_  
(Surety)

\_\_\_\_\_  
(Address)

By: \_\_\_\_\_

By: \_\_\_\_\_

STATE OF CALIFORNIA )  
 ) ss.  
CITY AND COUNTY OF \_\_\_\_\_

On \_\_\_\_\_, 2021 before me, \_\_\_\_\_, Notary Public, personally appeared \_\_\_\_\_, personally known to me (or proved to me on the basis of satisfactory evidence) to be the person(s) whose name(s) is/are subscribed to the within instrument and acknowledged to me that he/she/they executed the same in his/her/their authorized capacity(ies), and that by his/her/their signature(s) on the instrument the person(s), or the entity upon behalf of which the person(s) acted, executed the instrument.

I certify under PENALTY OF PERJURY under the laws of the State of California that the foregoing paragraph is true and correct.

Witness my hand and official seal.

Signature \_\_\_\_\_  
Notary Public

TO BE CONSIDERED COMPLETE, BOTH THE BIDDER AND AN ADMITTED SURETY INSURER AUTHORIZED BY THE CALIFORNIA INSURANCE COMMISSIONER TO TRANSACT SURETY BUSINESS IN THE STATE OF CALIFORNIA MUST SIGN THIS PERFORMANCE BOND. IN ADDITION, BOTH THE PRINCIPAL'S AND THE SURETY'S SIGNATURES MUST BE NOTARIZED AND A COPY OF THE SURETY'S POWER OF ATTORNEY MUST BE ATTACHED.